

FusionSolar Smart PV Management System Connection (Inverters + SDongle)

User Manual

Issue 05
Date 2024-01-15



Copyright © Huawei Digital Power Technologies Co., Ltd. 2024. All rights reserved.

No part of this document may be reproduced or transmitted in any form or by any means without prior written consent of Huawei Digital Power Technologies Co., Ltd.

Trademarks and Permissions



HUAWEI and other Huawei trademarks are the property of Huawei Technologies Co., Ltd.

All other trademarks and trade names mentioned in this document are the property of their respective holders.

Notice

The purchased products, services and features are stipulated by the contract made between Huawei Digital Power Technologies Co., Ltd. and the customer. All or part of the products, services and features described in this document may not be within the purchase scope or the usage scope. Unless otherwise specified in the contract, all statements, information, and recommendations in this document are provided "AS IS" without warranties, guarantees or representations of any kind, either express or implied. The information in this document is subject to change without notice. Every effort has been made in the preparation of this document to ensure accuracy of the contents, but all statements, information, and recommendations in this document do not constitute a warranty of any kind, express or implied.

Huawei Digital Power Technologies Co., Ltd.

Address: Huawei Digital Power Antuoshan Headquarters
Futian, Shenzhen 518043
People's Republic of China

Website: <https://e.huawei.com>

About This Document

Purpose





This document describes how to connect inverters to the FusionSolar Smart PV Management System through the Smart Dongle (SDongleA and SDongleB, also referred to as Dongle). For details about the installation of each device, see the corresponding user manual or quick guide. This document describes only cable connections between devices, power-on commissioning, and maintenance.

Intended Audience

This document is intended for photovoltaic (PV) plant operators and qualified electricians.

Symbol Conventions

The symbols that may be found in this document are defined as follows.

Symbol	Description
 DANGER	Indicates a hazard with a high level of risk which, if not avoided, will result in death or serious injury.
 WARNING	Indicates a hazard with a medium level of risk which, if not avoided, could result in death or serious injury.
 CAUTION	Indicates a hazard with a low level of risk which, if not avoided, could result in minor or moderate injury.
 NOTICE	Indicates a potentially hazardous situation which, if not avoided, could result in equipment damage, data loss, performance deterioration, or unanticipated results. NOTICE is used to address practices not related to personal injury.
 NOTE	Supplements the important information in the main text. NOTE is used to address information not related to personal injury, equipment damage, and environment deterioration.

Change History

Changes between document issues are cumulative. The latest document issue contains all the changes made in earlier issues.

Issue 05 (2024-01-15)

- Updated [2.2 Communication Networking of the SDongleA-03 \(4G\)](#).
- Updated [2.3 Communication Networking of the SDongleB-06 \(4G\)](#).

Issue 04 (2023-08-14)

Updated [5.2 Setting Grid-tied Control Parameters](#).

Issue 04 (2023-04-14)

- Updated [2 Introduction to the Solution](#).
- Updated [2.2 Communication Networking of the SDongleA-03 \(4G\)](#).
- Add [2.3 Communication Networking of the SDongleB-06 \(4G\)](#).
- Updated [2.4 Communication Networking of the SDongleA-05 \(WLAN-FE, 02312QMV\)](#).
- Add [3.3 Installing the 4G \(06\) Smart Dongle](#).
- Updated [5.2.1 Setting Parameters over the App](#).
- Add [5.3 Third-Party Management System Settings \(Connecting to Two Management Systems\)](#).
- Add [5.4 Setting Parameters and Exporting Logs Through the WLAN of the Smart Dongle](#).
- Updated [6.1 Modifying Inverter Communications Parameters](#).

Issue 03 (2022-03-15)

- Updated [2.2 Communication Networking of the SDongleA-03 \(4G\)](#).
- Updated [2.4 Communication Networking of the SDongleA-05 \(WLAN-FE, 02312QMV\)](#).
- Updated [3.1 Connecting Cables for Cascaded Inverters](#).

Issue 02 (2021-11-25)

- Updated [2.2 Communication Networking of the SDongleA-03 \(4G\)](#).
- Updated [2.4 Communication Networking of the SDongleA-05 \(WLAN-FE, 02312QMV\)](#).
- Updated [3.2 Installing the 4G/WLAN Smart Dongle](#).
- Updated [5.2 Setting Grid-tied Control Parameters](#).

Issue 01 (2020-12-10)

This issue is the first official release.

Contents

About This Document	ii
1 Safety Information	1
1.1 Personal Safety	2
1.2 Electrical Safety	4
1.3 Environment Requirements	5
1.4 Mechanical Safety	6
2 Introduction to the Solution	9
2.1 Communication Networking of the SDongleA-01 (WLAN)	10
2.2 Communication Networking of the SDongleA-03 (4G)	12
2.3 Communication Networking of the SDongleB-06 (4G)	21
2.4 Communication Networking of the SDongleA-05 (WLAN-FE, 02312QMV)	29
2.5 Communication Networking of the SDongleA-05 (WLAN-FE, 02312QMV-004)	32
3 Cable Connections	39
3.1 Connecting Cables for Cascaded Inverters	39
3.2 Installing the 4G/WLAN Smart Dongle	43
3.3 Installing the 4G (06) Smart Dongle	43
3.4 Installing the WLAN-FE Smart Dongle	44
4 System Power-On and Commissioning	45
4.1 Checking Before Power-On	45
4.2 Powering On the Inverter	45
5 Plant Creation and Commissioning	49
5.1 Creating a PV Plant	49
5.1.1 Creating a PV Plant over the App	49
5.1.2 Creating a PV Plant over the WebUI	51
5.2 Setting Grid-tied Control Parameters	55
5.2.1 Setting Parameters over the App	56
5.2.2 Setting Parameters over the WebUI	61
5.3 Third-Party Management System Settings (Connecting to Two Management Systems)	66
5.4 Setting Parameters and Exporting Logs Through the WLAN of the Smart Dongle	70
6 Maintenance	72
6.1 Modifying Inverter Communications Parameters	72

6.1.1 WLAN Communication Networking.....	72
6.1.2 4G Communication Networking.....	75
6.1.3 FE Communication Networking.....	77
6.2 Exporting Inverter and Smart Dongle Logs.....	79
6.3 Upgrading the Inverter and Smart Dongle Software.....	80
6.4 Updating the Device List.....	84
6.5 Replacing the Smart Dongle and the Master Inverter.....	85
6.5.1 Replacing the Smart Dongle.....	85
6.5.2 Replacing the Master Inverter.....	87
6.6 Troubleshooting Common Issues.....	88
7 Acronyms and Abbreviations.....	89

1 Safety Information

Statement

Before transporting, storing, installing, operating, using, and/or maintaining the equipment, read this document, strictly follow the instructions provided herein, and follow all the safety instructions on the equipment and in this document. In this document, "equipment" refers to the products, software, components, spare parts, and/or services related to this document; "the Company" refers to the manufacturer (producer), seller, and/or service provider of the equipment; "you" refers to the entity that transports, stores, installs, operates, uses, and/or maintains the equipment.

The **Danger, Warning, Caution, and Notice** statements described in this document do not cover all the safety precautions. You also need to comply with relevant international, national, or regional standards and industry practices. **The Company shall not be liable for any consequences that may arise due to violations of safety requirements or safety standards concerning the design, production, and usage of the equipment.**

The equipment shall be used in an environment that meets the design specifications. Otherwise, the equipment may be faulty, malfunctioning, or damaged, which is not covered under the warranty. The Company shall not be liable for any property loss, personal injury, or even death caused thereby.

Comply with applicable laws, regulations, standards, and specifications during transportation, storage, installation, operation, use, and maintenance.

Do not perform reverse engineering, decompilation, disassembly, adaptation, implantation, or other derivative operations on the equipment software. Do not study the internal implementation logic of the equipment, obtain the source code of the equipment software, violate intellectual property rights, or disclose any of the performance test results of the equipment software.

The Company shall not be liable for any of the following circumstances or their consequences:

- The equipment is damaged due to force majeure such as earthquakes, floods, volcanic eruptions, debris flows, lightning strikes, fires, wars, armed conflicts, typhoons, hurricanes, tornadoes, and other extreme weather conditions.
- The equipment is operated beyond the conditions specified in this document.

- The equipment is installed or used in environments that do not comply with international, national, or regional standards.
- The equipment is installed or used by unqualified personnel.
- You fail to follow the operation instructions and safety precautions on the product and in the document.
- You remove or modify the product or modify the software code without authorization.
- You or a third party authorized by you cause the equipment damage during transportation.
- The equipment is damaged due to storage conditions that do not meet the requirements specified in the product document.
- You fail to prepare materials and tools that comply with local laws, regulations, and related standards.
- The equipment is damaged due to your or a third party's negligence, intentional breach, gross negligence, or improper operations, or other reasons not related to the Company.

1.1 Personal Safety

 **DANGER**

Ensure that power is off during installation. Do not install or remove a cable with power on. Transient contact between the core of the cable and the conductor will generate electric arcs or sparks, which may cause a fire or personal injury.

 **DANGER**

Non-standard and improper operations on the energized equipment may cause fire, electric shocks, or explosion, resulting in property damage, personal injury, or even death.

 **DANGER**

Before operations, remove conductive objects such as watches, bracelets, bangles, rings, and necklaces to prevent electric shocks.

 **DANGER**

During operations, use dedicated insulated tools to prevent electric shocks or short circuits. The dielectric withstanding voltage level must comply with local laws, regulations, standards, and specifications.

Figure 1-1 Personal protective equipment

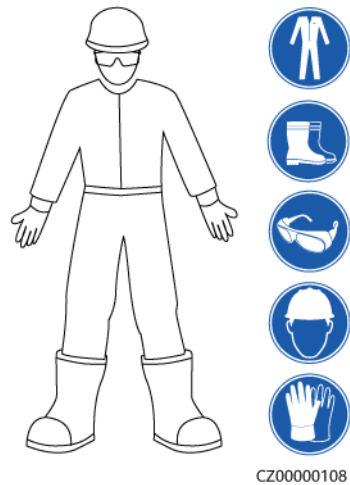

General Requirements

- Do not stop protective devices. Pay attention to the warnings, cautions, and related precautionary measures in this document and on the equipment.
- If there is a likelihood of personal injury or equipment damage during operations, immediately stop, report the case to the supervisor, and take feasible protective measures.
- Do not power on the equipment before it is installed or confirmed by professionals.
- In the case of a fire, immediately leave the building or the equipment area and activate the fire alarm or call emergency services. Do not enter the affected building or equipment area under any circumstances.

Personnel Requirements

- Only professionals and trained personnel are allowed to operate the equipment.
 - Professionals: personnel who are familiar with the working principles and structure of the equipment, trained or experienced in equipment operations and are clear of the sources and degree of various potential hazards in equipment installation, operation, maintenance
 - Trained personnel: personnel who are trained in technology and safety, have required experience, are aware of possible hazards on themselves in certain operations, and are able to take protective measures to minimize the hazards on themselves and other people
- Personnel who plan to install or maintain the equipment must receive adequate training, be able to correctly perform all operations, and understand all necessary safety precautions and local relevant standards.
- Only qualified professionals or trained personnel are allowed to install, operate, and maintain the equipment.
- Only qualified professionals are allowed to remove safety facilities and inspect the equipment.
- Personnel who will perform special tasks such as electrical operations, working at heights, and operations of special equipment must possess the required local qualifications.

- Only authorized professionals are allowed to replace the equipment or components (including software).
- Only personnel who need to work on the equipment are allowed to access the equipment.

1.2 Electrical Safety

 **DANGER**

Non-standard and improper operations may result in fire or electric shocks.

 **DANGER**

Prevent foreign matter from entering the equipment during operations. Otherwise, equipment damage, load power derating, power failure, or personal injury may occur.

 **WARNING**

For the equipment that needs to be grounded, install the ground cable first when installing the equipment and remove the ground cable last when removing the equipment.

General Requirements

- Follow the procedures described in the document for installation, operation, and maintenance. Do not reconstruct or alter the equipment, add components, or change the installation sequence without permission.
- Obtain approval from the national or local electric utility company before connecting the equipment to the grid.
- Before installing or removing power cables, turn off the switches of the equipment and its upstream and downstream switches.
- If any liquid is detected inside the equipment, disconnect the power supply immediately and do not use the equipment.
- Before performing operations on the equipment, check that all tools meet the requirements and record the tools. After the operations are complete, collect all of the tools to prevent them from being left inside the equipment.
- Before installing power cables, check that cable labels are correct and cable terminals are insulated.
- When installing the equipment, use a torque tool of a proper measurement range to tighten the screws. When using a wrench to tighten the screws, ensure that the wrench does not tilt and the torque error does not exceed 10% of the specified value.
- If the equipment has multiple inputs, disconnect all the inputs before operating the equipment.

- Check equipment connections periodically, ensuring that all screws are securely tightened.
- Only qualified professionals can replace a damaged cable.
- Do not scrawl, damage, or block any labels or nameplates on the equipment. Promptly replace labels that have worn out.
- Do not use solvents such as water, alcohol, or oil to clean electrical components inside or outside of the equipment.

Grounding

- Ensure that the grounding impedance of the equipment complies with local electrical standards.
- Ensure that the equipment is connected permanently to the protective ground. Before operating the equipment, check its electrical connection to ensure that it is reliably grounded.
- Do not work on the equipment in the absence of a properly installed ground conductor.
- Do not damage the ground conductor.
- For the equipment that uses a three-pin socket, ensure that the ground terminal in the socket is connected to the protective ground point.
- If high touch current may occur on the equipment, ground the protective ground terminal on the equipment enclosure before connecting the power supply; otherwise, electric shock as a result of touch current may occur.

Cabling Requirements

- When selecting, installing, and routing cables, follow local safety regulations and rules.
- When routing power cables, ensure that there is no coiling or twisting. Do not join or weld power cables. If necessary, use a longer cable.
- Ensure that all cables are properly connected and insulated, and meet specifications.
- Ensure that the slots and holes for routing cables are free from sharp edges, and that the positions where cables are routed through pipes or cable holes are equipped with cushion materials to prevent the cables from being damaged by sharp edges or burrs.
- Ensure that cables of the same type are bound together neatly and straight and that the cable sheath is intact. When routing cables of different types, ensure that they are away from each other without entanglement and overlapping.

1.3 Environment Requirements

 **DANGER**

Do not expose the equipment to flammable or explosive gas or smoke. Do not perform any operation on the equipment in such environments.

 **DANGER**

Do not place the equipment near heat sources or fire sources, such as smoke, candles, heaters, or other heating devices. Overheat may damage the equipment or cause a fire.

 **WARNING**

Install the equipment in an area far away from liquids. Do not install it under areas prone to condensation, such as under water pipes and air exhaust vents, or areas prone to water leakage, such as air conditioner vents, ventilation vents, or feeder windows of the equipment room. Ensure that no liquid enters the equipment to prevent faults or short circuits.

General Requirements

- Ensure that the equipment is stored in a clean, dry, and well ventilated area with proper temperature and humidity and is protected from dust and condensation.
- Keep the installation and operating environments of the equipment within the allowed ranges. Otherwise, its performance and safety will be compromised.
- Do not install, use, or operate outdoor equipment and cables (including but not limited to moving equipment, operating equipment and cables, inserting connectors to or removing connectors from signal ports connected to outdoor facilities, working at heights, performing outdoor installation, and opening doors) in harsh weather conditions such as lightning, rain, snow, and level 6 or stronger wind.
- Do not install the equipment in an environment with direct sunlight, dust, smoke, volatile or corrosive gases, infrared and other radiations, organic solvents, or salty air.
- Do not install the equipment in an environment with conductive metal or magnetic dust.
- Do not install the equipment in an area conducive to the growth of microorganisms such as fungus or mildew.
- Do not install the equipment in an area with strong vibration, noise, or electromagnetic interference.
- After installing the equipment, remove the packing materials such as cartons, foam, plastics, and cable ties from the equipment area.

1.4 Mechanical Safety

 **DANGER**

When working at heights, wear a safety helmet and safety harness or waist belt and fasten it to a solid structure. Do not mount it on an insecure moveable object or metal object with sharp edges. Make sure that the hooks will not slide off.

 **WARNING**

Ensure that all necessary tools are ready and inspected by a professional organization. Do not use tools that have signs of scratches or fail to pass the inspection or whose inspection validity period has expired. Ensure that the tools are secure and not overloaded.

 **WARNING**

Do not drill holes into the equipment. Doing so may affect the sealing performance and electromagnetic containment of the equipment and damage components or cables inside. Metal shavings from drilling may short-circuit boards inside the equipment.

General Requirements

- Do not perform operations such as arc welding and cutting on the equipment without evaluation by the Company.
- Do not install other devices on the top of the equipment without evaluation by the Company.
- Use correct tools and operate them in the correct way.

Moving Heavy Objects

- Be cautious to prevent injury when moving heavy objects.



< 18 kg
(< 40 lbs)



18–32 kg
(40–70 lbs)



32–55 kg
(70–121 lbs)

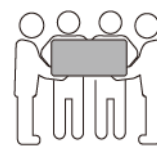

55–68 kg
(121–150 lbs)



> 68 kg
(> 150 lbs)

CZ0000110

- If multiple persons need to move a heavy object together, determine the manpower and work division with consideration of height and other conditions to ensure that the weight is equally distributed.
- If two persons or more move a heavy object together, ensure that the object is lifted and landed simultaneously and moved at a uniform pace under the supervision of one person.
- Wear personal protective gears such as protective gloves and shoes when manually moving the equipment.
- To move an object by hand, approach to the object, squat down, and then lift the object gently and stably by the force of the legs instead of your back. Do not lift it suddenly or turn your body around.
- Move or lift the equipment by holding its handles or lower kg edges. Do not hold the handles of modules that are installed in the equipment.
- Do not quickly lift a heavy object above your waist. Place the object on a workbench that is half-waist high or any other appropriate place, adjust the positions of your palms, and then lift it.

- Move a heavy object stably with balanced force at an even and low speed. Put down the object stably and slowly to prevent any collision or drop from scratching the surface of the equipment or damaging the components and cables.
- When moving a heavy object, be aware of the workbench, slope, staircase, and slippery places. When moving a heavy object through a door, ensure that the door is wide enough to move the object and avoid bumping or injury.
- When transferring a heavy object, move your feet instead of turning your waist around. When lifting and transferring a heavy object, ensure that your feet point to the target direction of movement.

2 Introduction to the Solution

This solution mainly applies to residential or small-scale ground-mounted PV plants, in which the inverter and power meter are connected to the FusionSolar Smart PV Management System through the Smart Dongle.

Table 2-1 Smart Dongle models

Model	Communications Mode	Description
SDongleA-01	WLAN	Connects to a router over a WLAN. The router connects to the FusionSolar Smart PV Management System over an IP network.
SDongleA-03-CN ^a SDongleA-03-EU SDongleA-03-AU SDongleA-03-JP SDongleA-03-KR SDongleB-06-CN ^a SDongleB-06-EU SDongleB-06-AU SDongleB-06-NH	4G	Connects to the FusionSolar Smart PV Management System through the 4G network by using a SIM card.
SDongleA-05	WLAN and FE	Connects to a router over WLAN or FE. The router connects to the FusionSolar Smart PV Management System over an IP network.

Note a: The SDongleA-03-CN and SDongleB-06-CN Smart Dongles are applicable only to the Chinese mainland. For other countries or regions, Huawei does not provide quality assurance.

Table 2-2 WLAN parameters

Technical Specification	Value Range
Frequency	2400 MHz–2483.5 MHz
Protocol standard	802.11b/g/n
Bandwidth	20M
Maximum transmit power	≤ 20 dBm EIRP

2.1 Communication Networking of the SDongleA-01 (WLAN)

- The inverter connects to the router through the WLAN Smart Dongle, and then connects to the FusionSolar Smart PV Management System through the router.
- The inverter connects to the FusionSolar app through its WLAN. You can use the FusionSolar app to view the running information and settings of the inverter.
- You can remotely log in to the FusionSolar Smart PV Management System over the WebUI or FusionSolar app.

Figure 2-1 Networking description

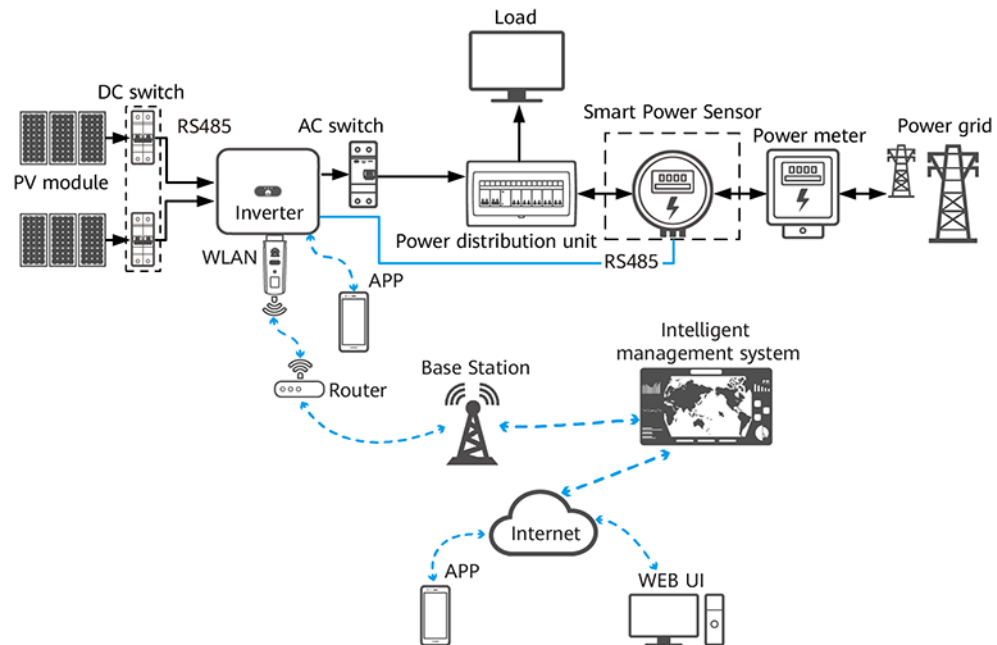

IL01N10021

 **NOTE**

- The components in the dotted box are optional.
- The inverter model is subject to change. The model information and device appearance in this document are for reference only.
- When multiple inverters are cascaded, only one Smart Dongle or SmartLogger can be connected to the RS485 communications link.
- When the Smart Dongle is used in China, it can be used for device cascading using RS485 communication (inverters cascading with inverters or other non-inverter devices). A maximum of 10 devices can be cascaded. In site communication scenarios, the number of inverters that can be cascaded also depends on the inverter features. When this Smart Dongle is used in other areas, device cascading using RS485 communication is not supported.

Table 2-3 Number of cascaded inverters

Limit	Actual Connection	
	Maximum Number of Devices That Can Be Connected to the Smart Dongle ^{ab}	Number of Slave Inverters
10	$n \leq 9$	$\leq 9 - n$
Note a: You can view the number of devices that can be connected to the Smart Dongle from the label on the external package. Note b: If the number of inverters exceeds the limit, configure multiple Smart Dongles. The installation and commissioning for each Smart Dongle are the same.		

Table 2-4 Device description

Device	Description	Service Owner
PV module	Prepared by the customer.	Device supplier
Inverter	SUN2000-(3KTL-20KTL)-M0. Software version: SUN2000MA V100R001C00SPC100 or later. Only one inverter can be connected.	Huawei
Dongle	Purchased by the customer. The model should be SDongleA-01.	Huawei

Device	Description	Service Owner
Router	<ul style="list-style-type: none"> The router supports WLAN (IEEE 802.11 b/g/n, 2.4 GHz), and the inverters are within the WLAN signal coverage. The WPA, WPA2, or WPA/WPA2 encryption mode is recommended. The Enterprise mode is not supported (such as airport WLAN and other public hotspots that require authentication). WEP and WPA TKIP encryption modes are not recommended because they have serious security vulnerabilities. If the access fails in WEP or WPA TKIP mode, log in to the router and change the encryption mode of the router to WPA2 or WPA/WPA2. 	Device supplier
Intelligent management system	FusionSolar Smart PV Management System. Software version: SmartPVMS V500R007C00SPC110 or later.	Huawei
App	FusionSolar app of 5.7.001 or a later version. The app can be locally connected to the inverter and remotely connected to the FusionSolar Smart PV Management System.	Huawei
Power distribution unit	Prepared by the customer	Device supplier
Smart Power Sensor	Recommended model: DTSU666-H	Huawei
Power meter	Prepared by the customer	Device supplier

2.2 Communication Networking of the SDongleA-03 (4G)

- The inverter connects to the FusionSolar Smart PV Management System through the 4G Smart Dongle.
- The master inverter connects to the FusionSolar app. You can use the FusionSolar app to view the running information and settings of the inverter.
- You can remotely log in to the FusionSolar Smart PV Management System over the WebUI or FusionSolar app.

RS485 Networking

Figure 2-2 Networking description

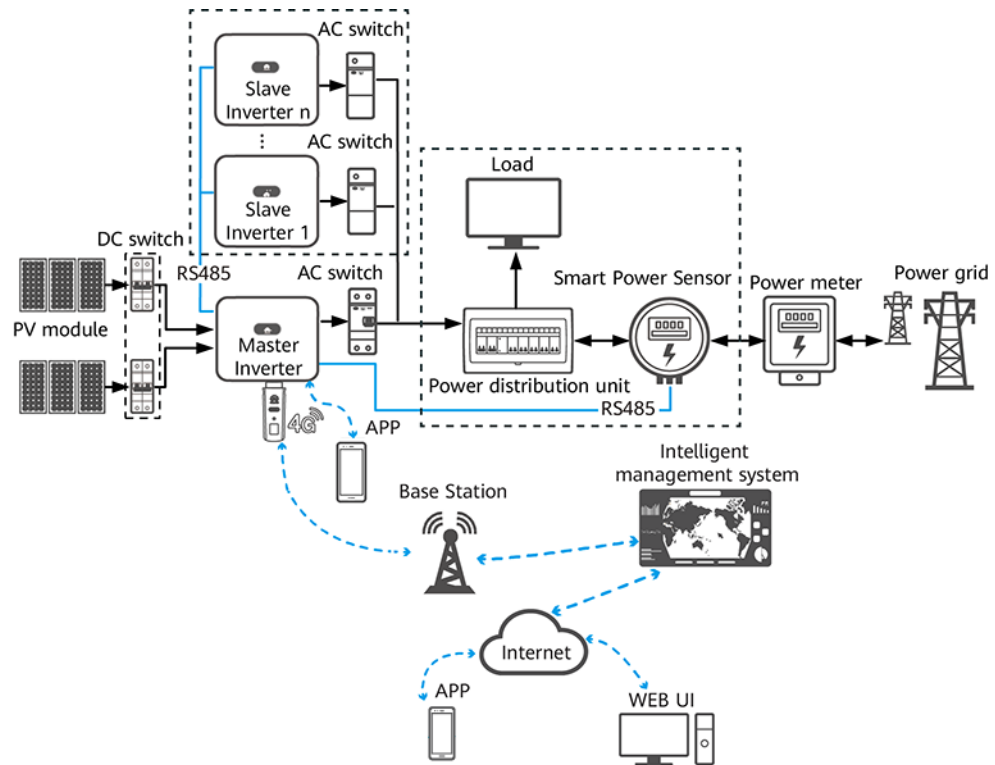

IL01N10022

NOTE

- The components in the dotted box are optional.
- The inverter model is subject to change. The model information and device appearance in this document are for reference only.
- In the networking, the inverter where the Dongle is installed is the master inverter, and other inverters are slave inverters. Slave inverters can communicate with the Dongle through cascading.
- If multiple inverters are cascaded, use either a Dongle or a SmartLogger for networking. You cannot use two networking methods at the same time.
- The Smart Power Sensor connects to the RS485-2 and RS485_2 ports, or 485B2 and 485A2 ports on the master inverter. The RS485-1 and RS485_1 ports, or 485B1 and 485A1 ports are used for inverter cascading.

Table 2-5 Device description

Device	Description	Service Owner
PV module	Prepared by the customer	Device supplier

Device		Description	Service Owner
Inverter	Master inverter	<ul style="list-style-type: none"> • SUN2000-(2KTL-5KTL)-CN or SUN2000-(2KTL-5KTL)-L0. Software version: SUN2000L V100R001C00SPC333 or later. • SUN2000-(2KTL-6KTL)-L1. Software version: SUN2000L V200R001C00 or later. • SUN2000-(3KTL-20KTL)-M0 • SUN2000-(3KTL-12KTL)-M1 • SUN2000-(8KTL-20KTL)-M2 • SUN2000-(20KTL-40KTL)-M3 • SUN2000-(50KTL-ZHM3, 50KTL-M3) • SUN2000-50KTL-NHM3 • SUN2000-(12KTL-25KTL)-M5 • SUN2000-70KTL/75KTL-C1 (optional), SUN2000-70KTL-INM0, SUN2000-50KTL/60KTL/65KTL-M0, SUN2000-50KTL/SUN2000-63KTL-JPM0, or SUN2000-50KTL-JPM1. Software version: SUN2000 V300R001C00SPC112 or later. • SUN2000-100KTL/110KTL/125KTL-M0, SUN2000-75KTL/100KTL-M1, or SUN2000-100KTL-INM0. • SUN2000-(100KTL, 110KTL, 115KTL)-M2 	Huawei
	Slave inverter	<ul style="list-style-type: none"> • A master inverter can be used as a slave inverter. A master inverter that does not support cascading, such as SUN2000-(2KTL-5KTL)-CN or SUN2000-(2KTL-5KTL)-L0, cannot be used as a slave inverter. • SUN2000-29.9KTL/36KTL/42KTL/50KTL • SUN2000-33KTL-A • SUN2000-33KTL/40KTL-JP • SUN2000-43KTL-IN-C1 • SUN2000-50KTL-C1 	Huawei
Dongle		Purchased by the customer. The model should be SDongleA-03-XX. For details, see the Smart Dongle models.	Huawei
SIM card		If the Smart Dongle is not configured with a SIM card, prepare a standard SIM card of the local carriers (size: 25 mm x 15 mm).	Customer
Intelligent management system		<ul style="list-style-type: none"> • Huawei management system: FusionSolar Smart PV Management System with the software version of SmartPVMS V500R007C00SPC110 or later. You are advised to use the latest version. • Third-party management system: A third-party management system is supported. For details, see the third-party management system documentation. 	Huawei

Device	Description	Service Owner
App	<ul style="list-style-type: none">• FusionSolar app of 5.7.001 or a later version. The app can be locally connected to the inverter and remotely connected to the FusionSolar Smart PV Management System.• SUN2000 app of 3.2.00.005 or a later version for Android. The app can be locally connected to the inverter.	Huawei
Power distribution unit	Prepared by the customer	Device supplier
Battery	Can connect to LUNA2000 batteries.	Huawei
Smart Power Sensor	<ul style="list-style-type: none">• Recommended models for three-phase inverters: DTSU666-H, YDS60-80, YDS60-C24, DTSU666-HW• Recommended models for single-phase inverters: DDSU666-H	Huawei
Power meter	Prepared by the customer	Device supplier

MBUS Communication Networking

- The inverter connects to the FusionSolar Smart PV Management System through the 4G Smart Dongle.
- The inverter connects to a phone through a Smart USB-WLAN Adapter (shortened to WLAN module in this document), Bluetooth module, or a data cable. You can use the SUN2000 app to view the running information and set inverter parameters locally.
- You can remotely log in to the FusionSolar Smart PV Management System over the WebUI or FusionSolar app.

NOTICE

The MBUS communication is applicable to medium-voltage grid connection scenarios and non-low-voltage public grid connection scenarios (industrial environment).

Figure 2-3 Networking description

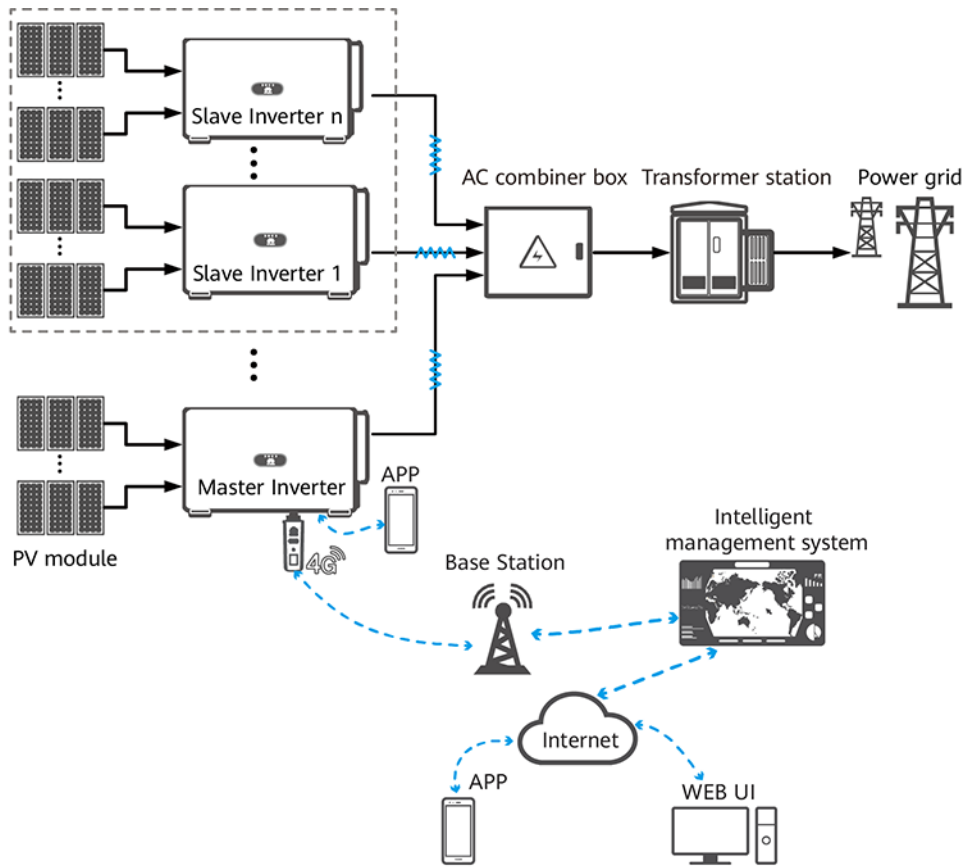

IL01N10023

NOTE

- The components in the dotted box are optional.
- The inverter model is subject to change. The model information and device appearance in this document are for reference only.
- In the networking, the inverter where the Dongle is installed is the master inverter, and other inverters are slave inverters. Slave inverters can communicate with the Dongle through cascading.
- If multiple inverters are cascaded, use either a Dongle or a SmartLogger for networking. You cannot use two networking methods at the same time.

Table 2-6 Device or software description

Device		Description	Service Owner
PV module		Prepared by the customer	Customer
Inverter	Master inverter	SUN2000-100KTL/110KTL/125KTL-M0. Software version: SUN2000 V500R001C00SPC100 or later.	Huawei
	Slave inverter	SUN2000-36KTL SUN2000-50KTL/60KTL-M0 SUN2000-100KTL/110KTL/125KTL-M0	Huawei

Device	Description	Service Owner
Dongle	Purchased by the customer. The model should be SDongleA-03-XX. For details, see the Smart Dongle models.	Huawei
SIM card	If the Smart Dongle is not configured with a SIM card, prepare a standard SIM card (size: 25 mm x 15 mm) of a local carrier.	Customer
Intelligent management system	<ul style="list-style-type: none"> Huawei management system: FusionSolar Smart PV Management System with the software version of SmartPVMS V500R007C00SPC110 or later. You are advised to use the latest version. Third-party management system: A third-party management system is supported. For details, see the third-party management system documentation. 	<ul style="list-style-type: none"> Huawei Device supplier
App	<ul style="list-style-type: none"> FusionSolar app of 5.7.001 or a later version. The app can be locally connected to the inverter and remotely connected to the FusionSolar Smart PV Management System. SUN2000 app of 3.2.00.005 or a later version for Android. The app is locally connected to the inverter. 	Huawei
AC combiner box	Prepared by the customer	Customer
Transformer station	Prepared by the customer	Customer
Power meter	Prepared by the customer	Device supplier

Smart Dongle Parameters

Table 2-7 Number of cascaded inverters

Limit		Actual Connection	
Maximum Number of Devices That Can Be Connected to the Smart Dongle ^{abcd}		Number of Slave Inverters	Number of Other Devices (Such as Power Meters)
10	10	$n \leq 9$	$\leq 9 - n$
	3 (with energy storage)	$n \leq 2$	$\leq 2 - n$
	3 (with single-phase inverters)	$n \leq 2$	$\leq 2 - n$
2	2	$n \leq 1$	$\leq 1 - n$

Limit	Actual Connection	
Maximum Number of Devices That Can Be Connected to the Smart Dongle^{abcd}	Number of Slave Inverters	Number of Other Devices (Such as Power Meters)
<p>Note a: You can view the number of devices that can be connected to the Smart Dongle from the label on the external package.</p> <p>Note b: If the number of inverters exceeds the limit, configure multiple Smart Dongles. The installation and commissioning for each Smart Dongle are the same.</p> <p>Note c: A maximum of three SUN2000-(2KTL-6KTL)-L1 inverters can be cascaded.</p> <p>Note d: If RS485 communication is used and the device is connected to the RS485-2 and RS485_2 ports, or 485B2 and 485A2 ports on the master inverter, the device is not counted as a cascaded device.</p>		

Table 2-8 Frequency bands and systems of the Smart Dongle

Model	Supported Frequency Bands and Systems	Protocol standard	Bandwidth	Maximum transmit power
SDongleA-03-CN	LTE FDD: B1, B3, B8 LTE TDD: B38, B39, B40, B41 DC-HSPA+/HSPA+/HSPA/UMTS: B1, B5, B8, B9 TD-SCDMA: B34, B39 GSM/GPRS/EDGE: 900 MHz, 1800 MHz	<ul style="list-style-type: none"> Supports LTE-FDD (with receive diversity): B1/B3/B7/B8/B20/B28. Supports LTE-FDD (with receive diversity): B38/B40/B41. Supports WCDMA: B1/B8. Supports GSM: 900 MHz/1800 MHz. Supports digital audio. 	LTE features: <ul style="list-style-type: none"> Supports a maximum of 3GPP R8 non-CA Cat 4 FDD and TDD. Supports 1.4 MHz/3 MHz/5 MHz/10 MHz/15 MHz/20 MHz RF bandwidth. Supports MIMO in the downlink. LTE-FDD: maximum downlink rate of 150 Mbit/s and maximum uplink rate of 50 Mbit/s LTE-TDD: maximum downlink rate of 130 Mbit/s and maximum uplink rate of 30 Mbit/s UMTS features: <ul style="list-style-type: none"> Supports 3GPP R7 HSDPA+, HSDPA, HSUPA, and WCDMA. Supports QPSK and 16QAM modulation. HSDPA+: maximum downlink rate of 21 Mbit/s HSUPA: maximum uplink rate of 5.76 Mbit/s WCDMA: maximum downlink rate of 384 kbit/s and maximum uplink rate of 384 kbit/s GSM features: GPRS: <ul style="list-style-type: none"> Supports GPRS multislots class 12. Coding schemes: CS-1, CS-2, CS-3, and CS-4 Maximum downlink rate: 85.6 kbit/s; maximum uplink rate: 85.6 kbit/s EDGE:	<ul style="list-style-type: none"> Class 4 (33 dBm±2 dB), EGSM900 frequency band Class 1 (30 dBm±2 dB), DCS1800 frequency band Class E2 (27 dBm±3 dB), EGSM900 8-PSK Class E2 (26 dBm±3 dB), DCS1800 8-PSK Class 3 (24 dBm+1/-3 dB), WCDMA frequency band Class 3 (23 dBm±2 dB), LTE-FDD frequency band Class 3 (23 dBm±2 dB), LTE-TDD frequency band
SDongleA-03-EU	LTE FDD: B1, B3, B7, B8, B20 LTE TDD: B38, B40 WCDMA/HSDPA/HSUPA/HSPA+: B1, B8 GSM/GPRS/EDGE: 900 MHz, 1800 MHz	<ul style="list-style-type: none"> Supports digital audio. 	UMTS features: <ul style="list-style-type: none"> Supports 3GPP R7 HSDPA+, HSDPA, HSUPA, and WCDMA. Supports QPSK and 16QAM modulation. HSDPA+: maximum downlink rate of 21 Mbit/s HSUPA: maximum uplink rate of 5.76 Mbit/s WCDMA: maximum downlink rate of 384 kbit/s and maximum uplink rate of 384 kbit/s GSM features: GPRS: <ul style="list-style-type: none"> Supports GPRS multislots class 12. Coding schemes: CS-1, CS-2, CS-3, and CS-4 Maximum downlink rate: 85.6 kbit/s; maximum uplink rate: 85.6 kbit/s EDGE:	<ul style="list-style-type: none"> Class 3 (24 dBm+1/-3 dB), WCDMA frequency band Class 3 (23 dBm±2 dB), LTE-FDD frequency band Class 3 (23 dBm±2 dB), LTE-TDD frequency band
SDongleA-03-AU	LTE FDD: B1, B2, B3, B4, B5, B7, B8, B28 LTE TDD: B40 WCDMA: B1, B2, B5, B8 GSM: 850 MHz, 900 MHz, 1800 MHz, 1900 MHz	<ul style="list-style-type: none"> Supports digital audio. 	GSM features: GPRS: <ul style="list-style-type: none"> Supports GPRS multislots class 12. Coding schemes: CS-1, CS-2, CS-3, and CS-4 Maximum downlink rate: 85.6 kbit/s; maximum uplink rate: 85.6 kbit/s EDGE:	<ul style="list-style-type: none"> Class 3 (23 dBm±2 dB), LTE-TDD frequency band

Model	Supported Frequency Bands and Systems	Protocol standard	Bandwidth	Maximum transmit power
SDongleA-03-JP	LTE FDD: B1, B3, B8, B18, B19, B26 LTE TDD: B41 WCDMA: B1, B6, B8, B19		<ul style="list-style-type: none"> Supports EDGE multislots class 12. Supports GMSK and 8-PSK modulation and coding schemes. Downlink coding format: MCS 1–9 Uplink coding format: MCS 1–9 Maximum downlink rate: 236.8 kbit/s; maximum uplink rate: 236.8 kbit/s 	
SDongleA-03-KR	LTE FDD: B1, B3, B5, B7 WCDMA: B1			

Table 2-9 Traffic requirements for the SIM card

Access Management System Type	Monthly Traffic Requirement for the SIM Card			Traffic Capability
FusionSolar Smart PV Management System	Inverter	Without a power sensor or energy storage	10 MB + 4 MB x Number of inverters	<ul style="list-style-type: none"> Device performance data can be updated every 5 minutes. The Smart Dongle logs, inverter logs, and I-V diagnosis data can be exported monthly. The Smart Dongle and inverters can be upgraded monthly.
		With a power sensor	10 MB + 7 MB x Number of inverters	
		With energy storage	13 MB + 7 MB x Number of inverters + 5 MB x Number of DC-DC converters	
		With a power sensor and energy storage	13 MB + 7 MB x Number of inverters + 5 MB x Number of DC-DC converters	
	With Smart PV Optimizers	Inverter data usage + 2 MB + 0.2 MB x Number of Smart PV Optimizers		

2.3 Communication Networking of the SDongleB-06 (4G)

- The inverter connects to the FusionSolar Smart PV Management System through the 4G Smart Dongle.
- The master inverter connects to the FusionSolar app. You can use the FusionSolar app to view the running information and settings of the inverter.
- The Smart Dongle can connect to a third-party management system.
- The Smart Dongle supports WLAN hotspots.
- You can remotely log in to the FusionSolar Smart PV Management System over the WebUI or FusionSolar app.

RS485 Networking

Figure 2-4 Networking description

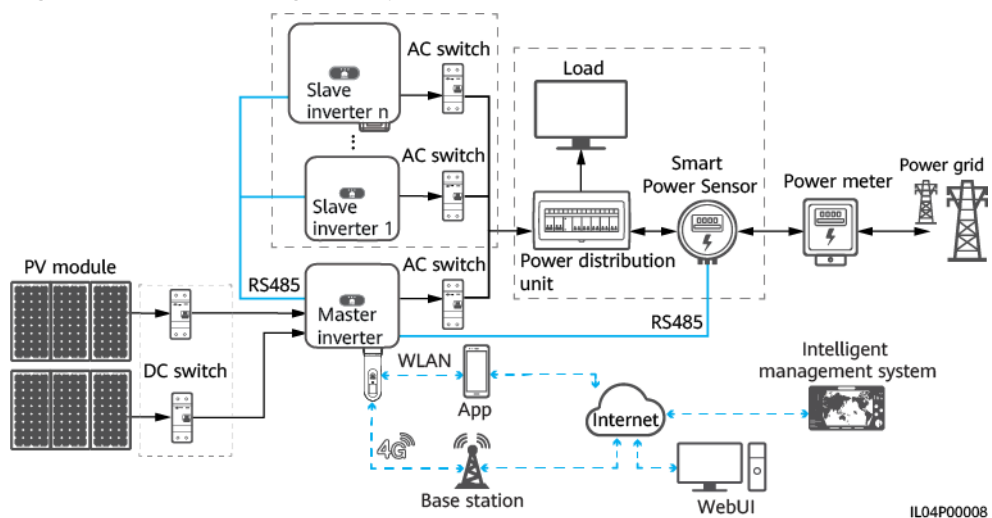

NOTE

- The components in the dotted box are optional.
- The inverter model is subject to change. The model information and device appearance in this document are for reference only.
- In the networking, the inverter where the Dongle is installed is the master inverter, and other inverters are slave inverters. Slave inverters can communicate with the Dongle through cascading.
- If multiple inverters are cascaded, use either a Dongle or a SmartLogger for networking. You cannot use two networking methods at the same time.
- The Smart Power Sensor connects to the RS485-2 and RS485_2 ports, or 485B2 and 485A2 ports on the master inverter. The RS485-1 and RS485_1 ports, or 485B1 and 485A1 ports are used for inverter cascading.

Table 2-10 Device description

Device		Description	Service Owner
PV module		Prepared by the customer	Device supplier
Inverter	Master inverter	<ul style="list-style-type: none"> ● SUN2000-(2KTL-5KTL)-CN or SUN2000-(2KTL-5KTL)-L0. Software version: SUN2000L V100R001C00SPC333 or later. ● SUN2000-(2KTL-6KTL)-L1 ● SUN2000-(3KTL-20KTL)-M0 ● SUN2000-(3KTL-12KTL)-M1 ● SUN2000-(8KTL-20KTL)-M2 ● SUN2000-(20KTL-40KTL)-M3 ● SUN2000-70KTL/75KTL-C1 (optional), SUN2000-70KTL-INM0, SUN2000-50KTL/60KTL/65KTL-M0, SUN2000-50KTL/SUN2000-63KTL-JPM0, or SUN2000-50KTL-JPM1. Software version: SUN2000 V300R001C00SPC112 or later. ● SUN2000-100KTL/110KTL/125KTL-M0, SUN2000-75KTL/100KTL-M1, or SUN2000-100KTL-INM0. ● SUN2000-(100KTL, 110KTL, 115KTL)-M2 ● SUN2000-(12KTL-25KTL)-M5 ● SUN2000-(50KTL-ZHM3, 50KTL-M3) ● SUN2000-50KTL-NHM3 	Huawei
	Slave inverter	<ul style="list-style-type: none"> ● A master inverter can be used as a slave inverter. A master inverter that does not support cascading, such as SUN2000-(2KTL-5KTL)-CN or SUN2000-(2KTL-5KTL)-L0, cannot be used as a slave inverter. ● SUN2000-29.9KTL/36KTL/42KTL/50KTL ● SUN2000-33KTL-A ● SUN2000-33KTL/40KTL-JP ● SUN2000-43KTL-IN-C1 ● SUN2000-50KTL-C1 	Huawei
Dongle		Purchased by the customer. The model should be SDongleB-06-XX. For details, see the Smart Dongle models.	Huawei
SIM card		If the Smart Dongle is not configured with a SIM card, prepare a standard SIM card of the local carriers (size: 25 mm x 15 mm).	Customer

Device	Description	Service Owner
Intelligent management system	<ul style="list-style-type: none"> • Huawei management system: FusionSolar Smart PV Management System with the software version of SmartPVMS V500R007C00SPC110 or later. You are advised to use the latest version. • Third-party management system: A third-party management system is supported. For details, see the third-party management system documentation. 	Huawei
App	<ul style="list-style-type: none"> • FusionSolar app of 5.7.001 or a later version. The app can be locally connected to the inverter and remotely connected to the FusionSolar Smart PV Management System. • SUN2000 app of 3.2.00.005 or a later version for Android. The app can be locally connected to the inverter. 	Huawei
Power distribution unit	Prepared by the customer	Device supplier
Battery	The LUNA2000 energy storage device is supported.	Huawei
Smart Power Sensor	<ul style="list-style-type: none"> • Recommended models for three-phase inverters: DTSU666-H, YDS60-80, YDS60-C24, DTSU666-HW • Recommended models for single-phase inverters: DDSU666-H 	Huawei
Power meter	Prepared by the customer	Device supplier

MBUS Communication Networking

- The inverter connects to the FusionSolar Smart PV Management System through the 4G Smart Dongle.
- The inverter connects to a phone through a Smart USB-WLAN Adapter (shortened to WLAN module in this document), Bluetooth module, or a data cable. You can use the SUN2000 app to view the running information and set inverter parameters locally.
- You can remotely log in to the FusionSolar Smart PV Management System over the WebUI or FusionSolar app.
- Procedure:
 - a. Open the FusionSolar app, log in to intl.fusionsolar.huawei.com using an installer account, and choose **Me > Device commissioning**. Then, scan the QR code on the WLAN module or the bar code on the Bluetooth module, or manually connect to the device via the WLAN hotspot, Bluetooth, or USB port to access the device commissioning screen.
 - b. Enter the login password.

- c. Tap **Log in** and go to the solar inverter screen. Choose **Settings > Communication configuration > Parallel system communication parameter settings > MBUS**. Insert the Dongle into the inverter whose parallel communication parameter is **MBUS**. Ensure that the parallel communication parameter of other inverters in the parallel system is **NA**.
- d. When using the Dongle to perform quick settings, set **Networking mode** to **MBUS**.

NOTICE

- The MBUS communication is applicable to medium-voltage grid connection scenarios and non-low-voltage public grid connection scenarios (industrial environment).
- To enable the anti-crosstalk function, you need to load a whitelist. Ensure that the PLC CCO version is SmartMBUS V100R001C00SPC220B220 or later.

Figure 2-5 Networking description

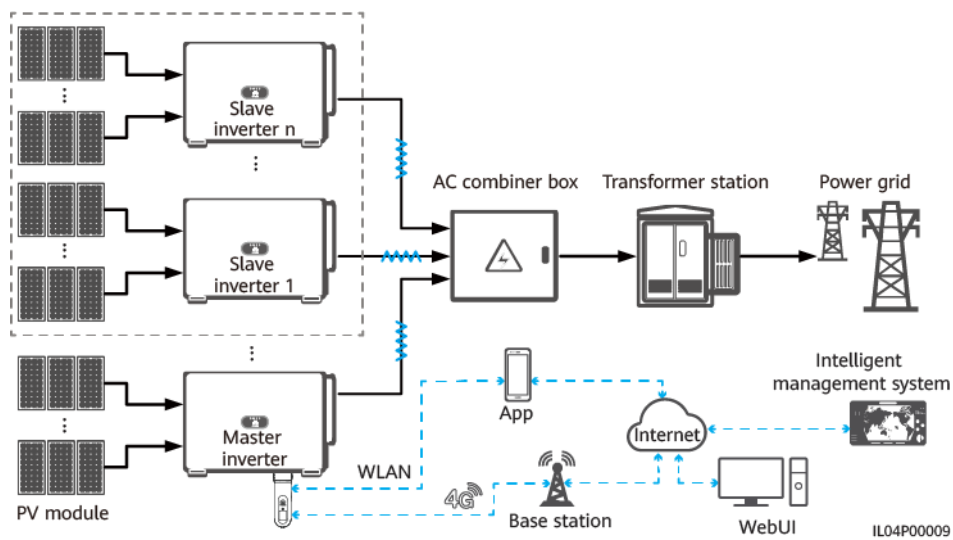

NOTE

- The components in the dotted box are optional.
- The inverter model is subject to change. The model information and device appearance in this document are for reference only.
- In the networking, the inverter where the Dongle is installed is the master inverter, and other inverters are slave inverters. Slave inverters can communicate with the Dongle through cascading.
- If multiple inverters are cascaded, use either a Dongle or a SmartLogger for networking. You cannot use two networking methods at the same time.

Table 2-11 Device or software description

Device	Description	Service Owner
PV module	Prepared by the customer	Customer

Device		Description	Service Owner
Inverter	Master inverter	<ul style="list-style-type: none"> SUN2000-(65KTL, 70KTL, 75KTL)-C1, SUN2000-(50KTL, 60KTL, 63KTL, 65KTL, 70KTL, 75KTL)-M0, SUN2000-(50KTL and 65KTL, 70KTL)-M1. Software version: SUN2000 V300R001C00SPC128B115 or later. SUN2000-100KTL/110KTL/125KTL-M0 and SUN2000-75KTL/110KTL-M1. Software version: SUN2000 V500R001C00SPC129B092 or later. SUN2000-(100KTL, 110KTL, 115KTL)-M2. Software version: SUN2000ME V500R023C00SPC030B128 or later. 	Huawei
	Slave inverter	A master inverter can be used as a slave inverter.	Huawei
Dongle		Purchased by the customer. The model should be SDongleB-06-XX. For details, see the Smart Dongle models. Software version: SDongle V200R022C10SPC103B016 or later.	Huawei
SIM card		If the Smart Dongle is not configured with a SIM card, prepare a standard SIM card (size: 25 mm x 15 mm) of a local carrier.	Customer
Intelligent management system		<ul style="list-style-type: none"> Huawei management system: FusionSolar Smart PV Management System. Third-party management system: A third-party management system is supported. For details, see the third-party management system documentation. 	<ul style="list-style-type: none"> Huawei Device supplier
App		<ul style="list-style-type: none"> FusionSolar app of 6.23.00.162 or a later version. The app can be locally connected to the inverter and remotely connected to the FusionSolar Smart PV Management System. SUN2000 app of 6.23.00.153 or a later version for Android. The app is locally connected to the inverter. 	Huawei
AC combiner box		Prepared by the customer	Customer
Transformer station		Prepared by the customer	Customer
Power meter		Prepared by the customer	Device supplier

Smart Dongle Parameters

Table 2-12 Number of cascaded inverters

Limit		Actual Connection	
Maximum Number of Devices That Can Be Connected to the Smart Dongle ^{abcd}		Number of Slave Inverters	Number of Other Devices (Such as Power Meters)
10	10	$n \leq 9$	$\leq 9 - n$
	3 (with energy storage)	$n \leq 2$	$\leq 2 - n$
	3 (with single-phase inverters)	$n \leq 2$	$\leq 2 - n$
2	2	$n \leq 1$	$\leq 1 - n$

Note a: You can view the number of devices that can be connected to the Smart Dongle from the label on the external package.

Note b: If the number of inverters exceeds the limit, configure multiple Smart Dongles. The installation and commissioning for each Smart Dongle are the same.

Note c: A maximum of three SUN2000-(2KTL-6KTL)-L1 inverters can be cascaded.

Note d: If RS485 communication is used and the device is connected to the RS485-2 and RS485_2 ports, or 485B2 and 485A2 ports on the master inverter, the device is not counted as a cascaded device.

Table 2-13 Basic specifications

Parameter Name	Description
SIM card type	Standard SIM card (25 mm x 15 mm)
Indicator	LED
Typical power consumption	3.5 W
Dimensions (W x H x D)	48 mm x 28 mm x 162 mm
Net weight	<ul style="list-style-type: none"> • 87 g • 120 g
Ingress protection (IP) rating	IP65
Operating temperature	-30°C to +65°C
Relative humidity	5%–95% RH
Storage temperature	-40°C to +70°C
Maximum altitude	4000 m

Table 2-14 Frequency bands and systems of the Smart Dongle

Model	Supported Frequency Bands and Systems	Protocol standard	Bandwidth	Maximum transmit power
SDongleB-06-CN	LTE FDD: B1, B3, B5, B8 LTE TDD: B34, B39, B40, B41 GSM/GPRS/EDGE: 900 MHz, 1800 MHz	<ul style="list-style-type: none"> Supports LTE FDD (with receive diversity): B1/B3/B5/B8. Supports LTE-TDD (with receive diversity): B7/B20/B28/B38/B40/B41. Supports GSM: 900 MHz/1800 MHz. Supports digital audio. 	<p>LTE features:</p> <ul style="list-style-type: none"> Supports a maximum of 3GPP R8 non-CA Cat 4 FDD and TDD. Supports 1.4 MHz/3 MHz/5 MHz/10 MHz/15 MHz/20 MHz RF bandwidth. Supports MIMO in the downlink. LTE-FDD: maximum downlink rate of 150 Mbit/s and maximum uplink rate of 50 Mbit/s LTE-TDD: maximum downlink rate of 130 Mbit/s and maximum uplink rate of 30 Mbit/s <p>UMTS features:</p> <ul style="list-style-type: none"> Supports 3GPP R7 HSDPA+, HSDPA, HSUPA, and WCDMA. Supports QPSK and 16QAM modulation. HSDPA+: maximum downlink rate of 21 Mbit/s HSUPA: maximum uplink rate of 5.76 Mbit/s WCDMA: maximum downlink rate of 384 kbit/s and maximum uplink rate of 384 kbit/s <p>GSM features:</p> <p>GPRS:</p> <ul style="list-style-type: none"> Supports GPRS multislot class 12. Coding schemes: CS-1, CS-2, CS-3, and CS-4 Maximum downlink rate: 85.6 kbit/s; maximum uplink rate: 85.6 kbit/s <p>EDGE:</p> <ul style="list-style-type: none"> Supports EDGE multislot class 12. 	<ul style="list-style-type: none"> Class 4 (33 dBm±2 dB), EGSM900 frequency band Class 1 (30 dBm±2 dB), DCS1800 frequency band Class E2 (27 dBm±3 dB), EGSM900 8-PSK Class E2 (26 dBm±3 dB), DCS1800 8-PSK Class 3 (24 dBm+1/-3 dB), WCDMA frequency band Class 3 (23 dBm±2 dB), LTE-FDD frequency band Class 3 (23 dBm±2 dB), LTE-TDD frequency band
SDongleB-06-EU	LTE FDD: B1, B3, B7, B8, B20, B28, B31 LTE TDD: B38, B40, B41 GSM/GPRS/EDGE: 850 MHz, 900 MHz, 1800 MHz, 1900 MHz			
SDongleB-06-AU	LTE FDD: B2, B4, B12 WCDMA: B1, B2, B5, B8 GSM: 850 MHz, 900 MHz, 1800 MHz, 1900 MHz			
SDongleB-06-NH	LTE FDD: B1, B3, B8, B18, B19, B26 LTE TDD: B41 WCDMA: B1, B6, B8, B19			SDongleB-06 (WiFi): ≤ 20 dBm EIRP

Model	Supported Frequency Bands and Systems	Protocol standard	Bandwidth	Maximum transmit power
			<ul style="list-style-type: none"> Supports GMSK and 8-PSK modulation and coding schemes. Downlink coding format: MCS 1-9 Uplink coding format: MCS 1-9 Maximum downlink rate: 236.8 kbit/s; maximum uplink rate: 236.8 kbit/s SDongleB-06 (WiFi): 20 MHz/40 MHz (optional)	

Table 2-15 Traffic requirements for the SIM card

Access Management System Type	Monthly Traffic Requirement for the SIM Card			Traffic Capability
FusionSolar Smart PV Management System	Inverter	Without a power sensor or energy storage	15 MB + 4 MB x Number of inverters	<ul style="list-style-type: none"> Device performance data can be updated every 5 minutes. The Smart Dongle logs, inverter logs, and I-V diagnosis data can be exported monthly. The Smart Dongle and inverters can be upgraded monthly.
		With a power sensor	15 MB + 7 MB x Number of inverters	
		With energy storage	18 MB + 7 MB x Number of inverters + 5 MB x Number of DC-DC converters	
		With a power sensor and energy storage	18 MB + 7 MB x Number of inverters + 5 MB x Number of DC-DC converters	
	With Smart PV Optimizers	Inverter data usage + 2 MB + 0.2 MB x Number of Smart PV Optimizers		

Smart Dongle WLAN

Commission the inverter locally via the Smart Dongle WLAN. If the Smart Dongle WLAN is disabled, log in to the FusionSolar app and tap the plant name on the

Home screen to access the plant screen. Tap **Devices** and then tap **SDongleB-06**. Choose **O&M Authorization** > **WLAN wakeup** > **Confirm** to enable the Smart Dongle WLAN.

NOTE

If the inverter has a built-in WLAN module, the Smart Dongle WLAN is disabled by default. If the inverter does not have a WLAN module, the Smart Dongle WLAN is enabled by default.

Figure 2-6 Enabling the Smart Dongle WLAN

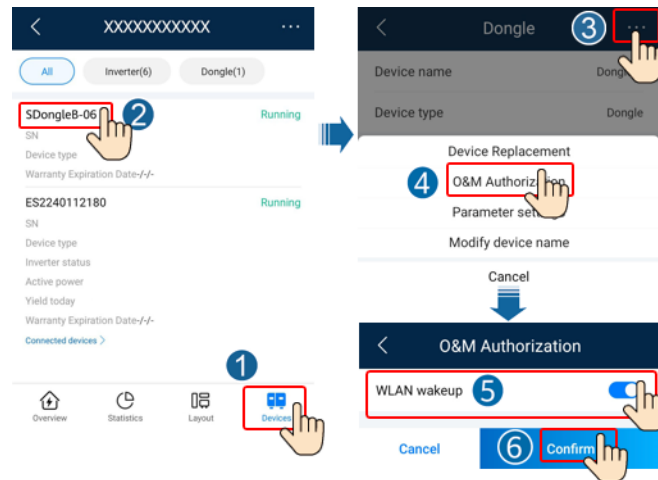

2.4 Communication Networking of the SDongleA-05 (WLAN-FE, 02312QMV)

Smart Dongle (BOM Number: 02312QMV)

- The inverter connects to the router through the WLAN-FE Smart Dongle, and then connects to the FusionSolar Smart PV Management System through the router.
- The master inverter connects to the FusionSolar app through its WLAN. You can use the FusionSolar app to view the running information and settings of the inverter.
- You can remotely log in to the FusionSolar Smart PV Management System over the WebUI or FusionSolar app.

Figure 2-7 Networking description (WLAN-FE)

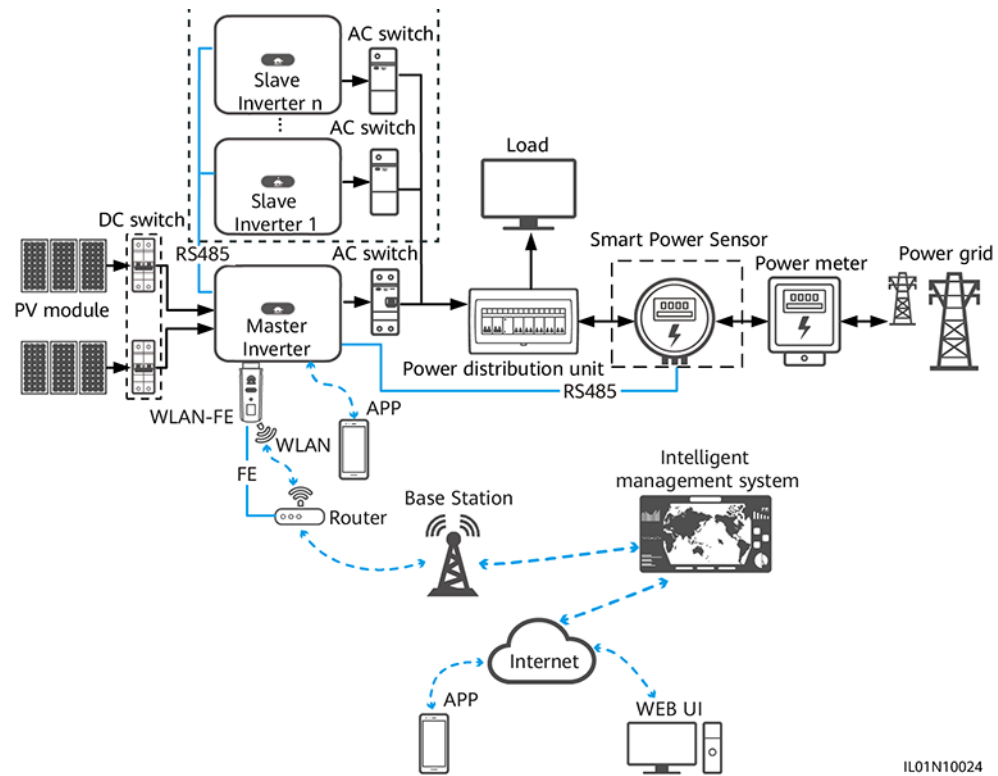

IL01N10024

NOTE

- The components in the dotted box are optional.
- The inverter model is subject to change. The model information and device appearance in this document are for reference only.
- In the networking, the inverter where the Dongle is installed is the master inverter, and other inverters are slave inverters. Slave inverters can communicate with the Dongle through cascading.
- If multiple inverters are cascaded, use either a Dongle or a SmartLogger for networking. You cannot use two networking methods at the same time.
- The Smart Power Sensor connects to the RS485-2 and RS485_2 ports, or 485B2 and 485A2 ports on the master inverter. The RS485-1 and RS485_1 ports, or 485B1 and 485A1 ports are used for inverter cascading.

Table 2-16 Number of cascaded inverters

Limit		Actual Connection	
Maximum Number of Devices That Can Be Connected to the Smart Dongle ^{abcd}		Number of Slave Inverters	Number of Other Devices (Such as Power Meters)
10	10	$n \leq 9$	$\leq 9 - n$
	3 (with energy storage)	$n \leq 2$	$\leq 2 - n$
	3 (with single-phase inverters)	$n \leq 2$	$\leq 2 - n$

Limit	Actual Connection	
Maximum Number of Devices That Can Be Connected to the Smart Dongle ^{abcd}	Number of Slave Inverters	Number of Other Devices (Such as Power Meters)
<p>Note a: You can view the number of devices that can be connected to the Smart Dongle from the label on the external package.</p> <p>Note b: If the number of inverters exceeds the limit, configure multiple Smart Dongles. The installation and commissioning for each Smart Dongle are the same.</p> <p>Note c: A maximum of three SUN2000-(2KTL-6KTL)-L1 inverters can be cascaded.</p> <p>Note d: If RS485 communication is used and the device is connected to the RS485-2 and RS485_2 ports, or 485B2 and 485A2 ports on the master inverter, the device is not counted as a cascaded device.</p>		

Table 2-17 Device description

Device		Description	Service Owner
PV module		Purchased by the customer	Device supplier
Inverter	Master inverter	<ul style="list-style-type: none"> ● SUN2000-(2KTL-6KTL)-L1 ● SUN2000-(3KTL-20KTL)-M0 ● SUN2000-(3KTL-12KTL)-M1 ● SUN2000-(8KTL-20KTL)-M2 ● SUN2000-(20KTL-40KTL)-M3 ● SUN2000-(50KTL-ZHM3, 50KTL-M3) ● SUN2000-(12KTL-25KTL)-M5 	Huawei
	Slave inverter	<ul style="list-style-type: none"> ● A master inverter can be used as a slave inverter. ● SUN2000-33KTL ● SUN2000-29.9KTL/33KTL-A/36KTL ● SUN2000-50KTL/60KTL-M0 ● SUN2000-100KTL/110KTL-M0 	Huawei
Dongle		Purchased by the customer. The model should be SDongleA-05.	Huawei

Device	Description	Service Owner
Router	<ul style="list-style-type: none"> The router supports WLAN (IEEE 802.11 b/g/n, 2.4 GHz), and the inverters are within the WLAN signal coverage. The WPA, WPA2, or WPA/WPA2 encryption mode is recommended. The Enterprise mode is not supported (such as airport WLAN and other public hotspots that require authentication). WEP and WPA TKIP encryption modes are not recommended because they have serious security vulnerabilities. If the access fails in WEP or WPA TKIP mode, log in to the router and change the encryption mode of the router to WPA2 or WPA/WPA2. 	Device supplier
Intelligent management system	FusionSolar Smart PV Management System. Software version: SmartPVMS V500R007C00SPC110 or later.	Huawei
App	FusionSolar app of 5.7.001 or a later version. The app can be locally connected to the inverter and remotely connected to the FusionSolar Smart PV Management System.	Huawei
Power distribution unit	Prepared by the customer	Device supplier
Battery	The LUNA2000 energy storage device is supported.	Huawei
Smart Power Sensor	<ul style="list-style-type: none"> Recommended models for three-phase inverters: DTSU666-H, YDS60-80, YDS60-C24, DTSU666-HW Recommended models for single-phase inverters: DDSU666-H 	Huawei
Power meter	Prepared by the customer	Device supplier

2.5 Communication Networking of the SDongleA-05 (WLAN-FE, 02312QMV-004)

Smart Dongle (BOM Number: 02312QMV-004)

- The inverter connects to the router through the WLAN-FE Smart Dongle, and then connects to the FusionSolar Smart PV Management System through the router.
- The Smart Dongle can connect to a third-party management system.
- The Smart Dongle supports WLAN hotspots.

- The master inverter connects to the FusionSolar app through its WLAN. You can use the FusionSolar app to view the running information and settings of the inverter.
- You can remotely log in to the FusionSolar Smart PV Management System over the WebUI or FusionSolar app.

RS485 Networking

Figure 2-8 Networking description (WLAN-FE)

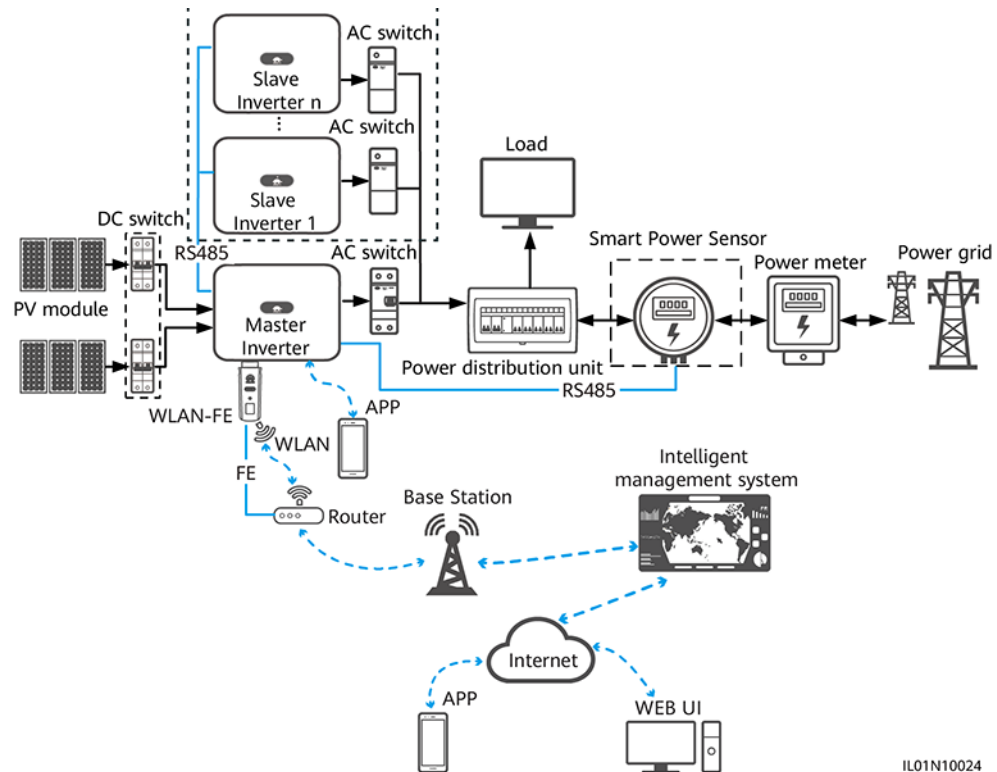

IL01N10024

NOTE

- The components in the dotted box are optional.
- The inverter model is subject to change. The model information and device appearance in this document are for reference only.
- In the networking, the inverter where the Dongle is installed is the master inverter, and other inverters are slave inverters. Slave inverters can communicate with the Dongle through cascading.
- If multiple inverters are cascaded, use either a Dongle or a SmartLogger for networking. You cannot use two networking methods at the same time.
- The Smart Power Sensor connects to the RS485-2 and RS485_2 ports, or 485B2 and 485A2 ports on the master inverter. The RS485-1 and RS485_1 ports, or 485B1 and 485A1 ports are used for inverter cascading.

Table 2-18 Number of cascaded inverters

Limit		Actual Connection	
Maximum Number of Devices That Can Be Connected to the Smart Dongle ^{abcd}		Number of Slave Inverters	Number of Other Devices (Such as Power Meters)
10	10	$n \leq 9$	$\leq 9 - n$
	3 (with energy storage)	$n \leq 2$	$\leq 2 - n$
	3 (with single-phase inverters)	$n \leq 2$	$\leq 2 - n$

Note a: You can view the number of devices that can be connected to the Smart Dongle from the label on the external package.

Note b: If the number of inverters exceeds the limit, configure multiple Smart Dongles. The installation and commissioning for each Smart Dongle are the same.

Note c: A maximum of three SUN2000-(2KTL-6KTL)-L1 inverters can be cascaded.

Note d: If RS485 communication is used and the device is connected to the RS485-2 and RS485_2 ports, or 485B2 and 485A2 ports on the master inverter, the device is not counted as a cascaded device.

Table 2-19 Device description

Device		Description	Service Owner
PV module		Purchased by the customer	Device supplier
Inverter	Master inverter	<ul style="list-style-type: none"> SUN2000-(2KTL-5KTL)-L0, SUN2000-(2KTL-6KTL)-L1. Software version: SUN2000L V200R001C00 or later. (all software versions of this inverter model are supported.) SUN2000-(3KTL-20KTL)-M0 SUN2000-(3KTL-12KTL)-M1 SUN2000-(8KTL-20KTL)-M2 SUN2000-(20KTL-40KTL)-M3 SUN2000-(50KTL-ZHM3, 50KTL-M3) SUN2000-(12KTL-25KTL)-M5 SUN2000-(100KTL, 110KTL, 115KTL)-M2 	Huawei
	Slave inverter	<ul style="list-style-type: none"> A master inverter can be used as a slave inverter. SUN2000-33KTL SUN2000-29.9KTL/33KTL-A/36KTL SUN2000-50KTL/60KTL-M0 SUN2000-100KTL/110KTL-M0 	Huawei
Dongle		Purchased by the customer. The model should be SDongleA-05.	Huawei

Device	Description	Service Owner
Router	<ul style="list-style-type: none"> The router supports WLAN (IEEE 802.11 b/g/n, 2.4 GHz), and the inverters are within the WLAN signal coverage. The WPA, WPA2, or WPA/WPA2 encryption mode is recommended. The Enterprise mode is not supported (such as airport WLAN and other public hotspots that require authentication). WEP and WPA TKIP encryption modes are not recommended because they have serious security vulnerabilities. If the access fails in WEP or WPA TKIP mode, log in to the router and change the encryption mode of the router to WPA2 or WPA/WPA2. 	Device supplier
Intelligent management system	FusionSolar Smart PV Management System. Software version: SmartPVMS V500R007C00SPC110 or later.	Huawei
App	FusionSolar app of 5.7.001 or a later version. The app can be locally connected to the inverter and remotely connected to the FusionSolar Smart PV Management System.	Huawei
Power distribution unit	Prepared by the customer	Device supplier
Battery	The LUNA2000 energy storage device is supported.	Huawei
Smart Power Sensor	<ul style="list-style-type: none"> Recommended models for three-phase inverters: DTSU666-H, YDS60-80, YDS60-C24, DTSU666-HW Recommended models for single-phase inverters: DDSU666-H 	Huawei
Power meter	Prepared by the customer	Device supplier

MBUS Communication Networking

- The inverter connects to the router through the WLAN-FE Smart Dongle, and then connects to the FusionSolar Smart PV Management System through the router.
- The inverter connects to a phone through a Smart USB-WLAN Adapter (shortened to WLAN module in this document), Bluetooth module, or a data cable. You can use the SUN2000 app to view the running information and set inverter parameters locally.
- You can remotely log in to the FusionSolar Smart PV Management System over the WebUI or FusionSolar app.
- Procedure:

- a. Open the FusionSolar app, log in to intl.fusionsolar.huawei.com using an installer account, and choose **Me > Device commissioning**. Then, scan the QR code on the WLAN module or the bar code on the Bluetooth module, or manually connect to the device via the WLAN hotspot, Bluetooth, or USB port to access the device commissioning screen.
- b. Enter the login password.
- c. Tap **Log in** and go to the solar inverter screen. Choose **Settings > Communication configuration > Parallel system communication parameter settings > MBUS**. Insert the Dongle into the inverter whose parallel communication parameter is **MBUS**. Ensure that the parallel communication parameter of other inverters in the parallel system is **NA**.
- d. When using the Dongle to perform quick settings, set **Networking mode** to **MBUS**.

NOTICE

- The MBUS communication is applicable to medium-voltage grid connection scenarios and non-low-voltage public grid connection scenarios (industrial environment).
- To enable the anti-crosstalk function, you need to load a whitelist. Ensure that the PLC CCO version is SmartMBUS V100R001C00SPC220B220 or later.

Figure 2-9 Networking description (WLAN-FE)

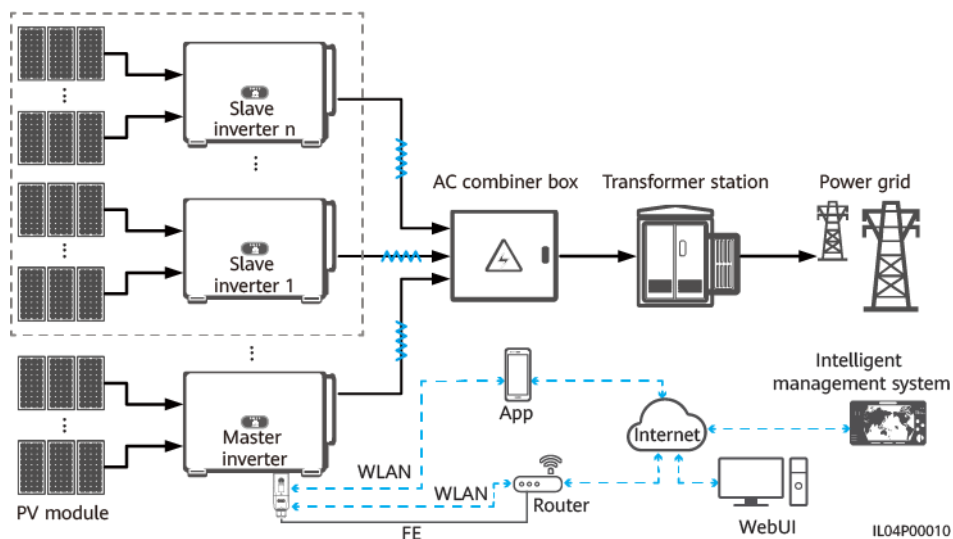

NOTE

- The components in the dotted box are optional.
- The inverter model is subject to change. The model information and device appearance in this document are for reference only.
- In the networking, the inverter where the Dongle is installed is the master inverter, and other inverters are slave inverters. Slave inverters can communicate with the Dongle through cascading.
- If multiple inverters are cascaded, use either a Dongle or a SmartLogger for networking. You cannot use two networking methods at the same time.

Table 2-20 Device or software description

Device		Description	Service Owner
PV module		Prepared by the customer	Customer
Inverter	Master inverter	<ul style="list-style-type: none"> SUN2000-(65KTL, 70KTL, 75KTL)-C1, SUN2000-(50KTL, 60KTL, 63KTL, 65KTL, 70KTL, 75KTL)-M0 and SUN2000-(50KTL, 65KTL, 70KTL)-M1. Software version: SUN2000 V300R001C00SPC128B115 or later. SUN2000-100KTL/110KTL/125KTL-M0 and SUN2000-75KTL/110KTL-M1. Software version: SUN2000 V500R001C00SPC129B092 or later. SUN2000-(100KTL, 110KTL, 115KTL)-M2. Software version: SUN2000ME V500R023C00SPC030B128 or later. 	Huawei
	Slave inverter	A master inverter can be used as a slave inverter.	Huawei
Dongle		Purchased by the customer. The model should be SDongleA-05. For details, see the Smart Dongle models. Software version: SDongle V200R022C10SPC103B016 or later.	Huawei
Intelligent management system		<ul style="list-style-type: none"> Huawei management system: FusionSolar Smart PV Management System. Third-party management system: A third-party management system is supported. For details, see the third-party management system documentation. 	<ul style="list-style-type: none"> Huawei Device supplier
App		<ul style="list-style-type: none"> FusionSolar app of 6.23.00.162 or a later version. The app can be locally connected to the inverter and remotely connected to the FusionSolar Smart PV Management System. SUN2000 app of 6.23.00.153 or a later version for Android. The app is locally connected to the inverter. 	Huawei
AC combiner box		Prepared by the customer	Customer
Transformer station		Prepared by the customer	Customer
Power meter		Prepared by the customer	Device supplier

Smart Dongle WLAN

Commission the inverter locally via the Smart Dongle WLAN. If the Smart Dongle WLAN is disabled, log in to the FusionSolar app and tap the plant name on the **Home** screen to access the plant screen. Tap **Devices** and then tap **SDongleA-05**. Choose **O&M Authorization > WLAN wakeup > Confirm** to enable the Smart Dongle WLAN.

 NOTE

If the inverter has a built-in WLAN module, the Smart Dongle WLAN is disabled by default. If the inverter does not have a WLAN module, the Smart Dongle WLAN is enabled by default.

Figure 2-10 Enabling the Smart Dongle WLAN

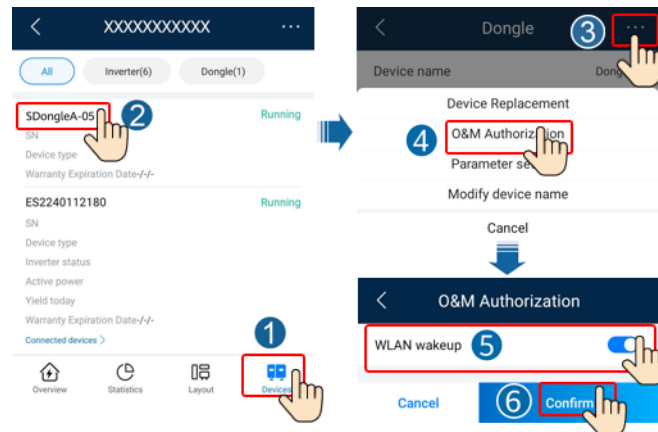

3 Cable Connections

3.1 Connecting Cables for Cascaded Inverters

This document provides only the schematic diagram of inverter cascading. For details about communications port definitions and cable connections, see the user manual of each inverter.

Figure 3-1 Cable connections for cascaded inverters

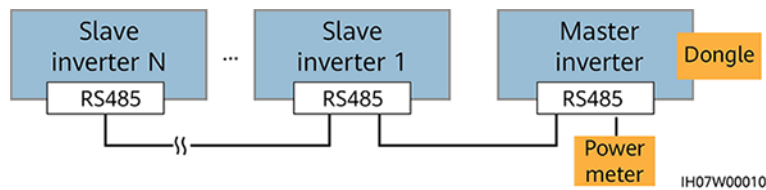

NOTICE

- Ensure that the shield layer is grounded when connecting the RS485 cable.
- When laying out communications cables, separate them from power cables and keep them away from strong interference sources to prevent communication interruption.

Figure 3-2 Connecting cables to the DTSU666-H (three-phase three-wire)

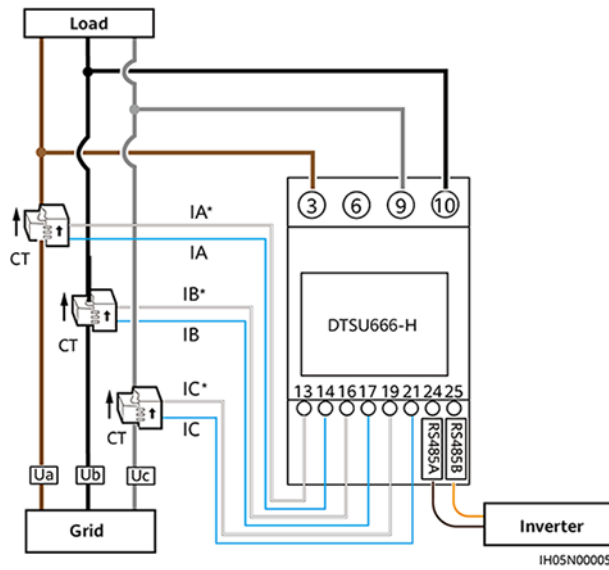

Figure 3-3 Connecting cables to the DTSU666-H (three-phase four-wire)

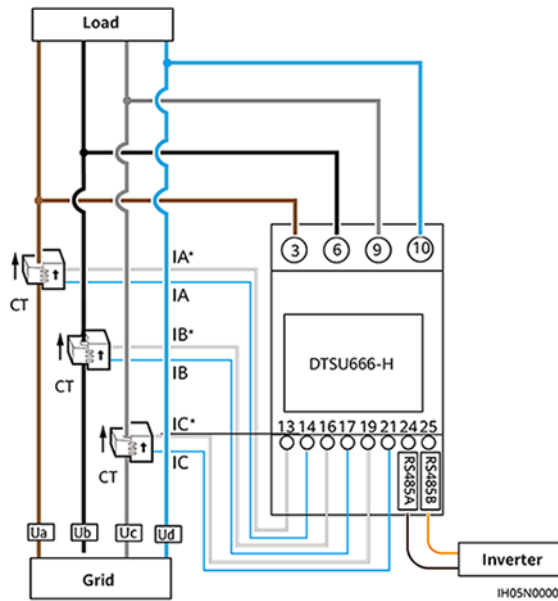

Figure 3-4 Connecting cables between the inverter and DTSU666-HW or YDS60-80 (three-phase three-wire direct connection)

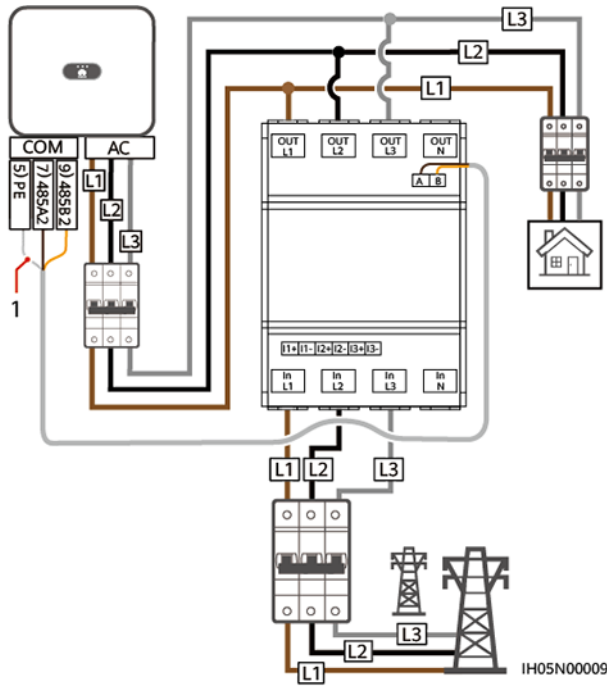

Figure 3-5 Connecting cables between the inverter and DTSU666-HW or YDS60-80 (three-phase three-wire CT connection)

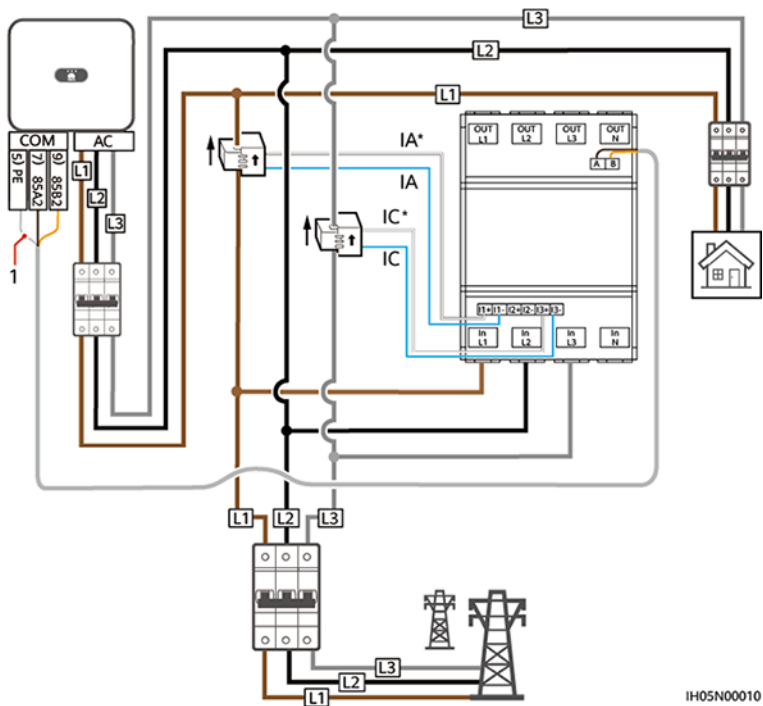

Figure 3-6 Connecting cables between the inverter and DTSU666-HW or YDS60-80 (three-phase four-wire direct connection)

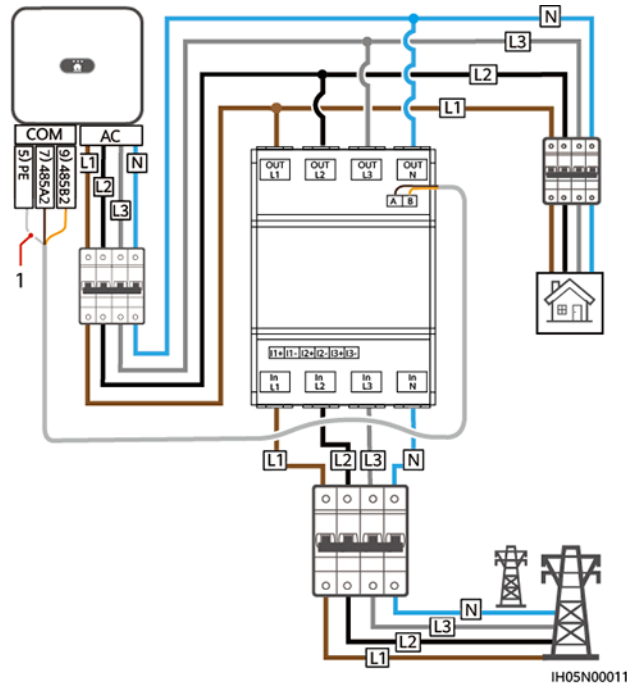
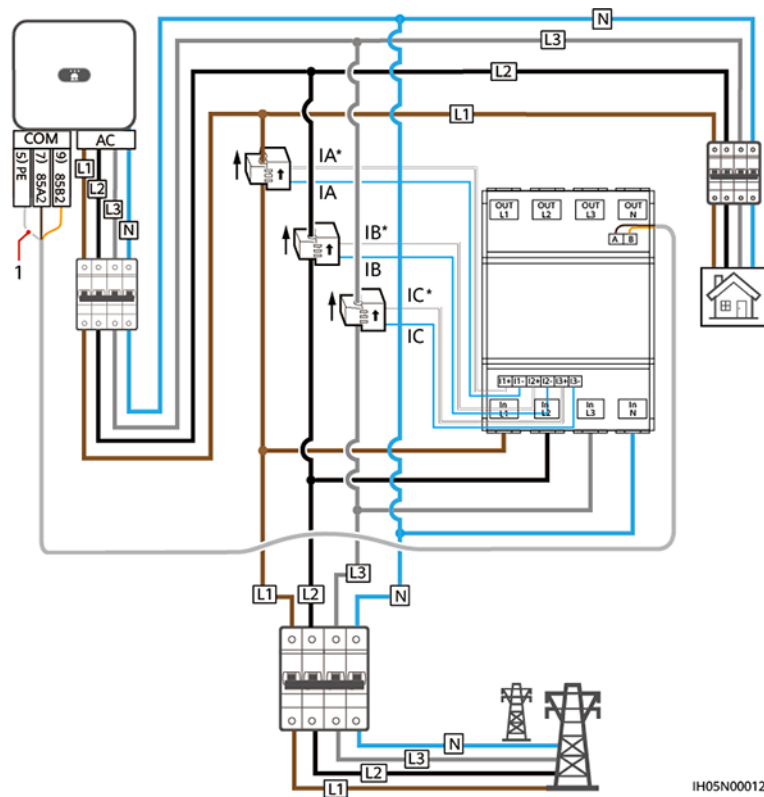

Figure 3-7 Connecting cables between the inverter and DTSU666-HW or YDS60-80 (three-phase four-wire CT connection)



3.2 Installing the 4G/WLAN Smart Dongle

Step 1 Install a SIM card. (Skip this step for the WLAN Smart Dongle or the Smart Dongle that is configured with a SIM card.)

Figure 3-8 Installing a SIM card

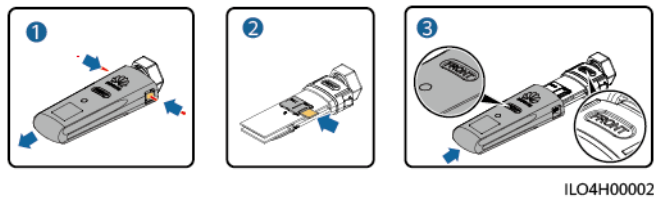

Step 2 Install the Smart Dongle onto the USB port on the master inverter.

Figure 3-9 Installing a Smart Dongle

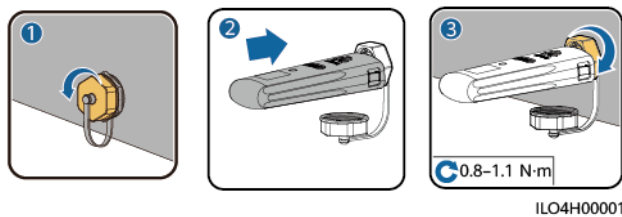

----End

3.3 Installing the 4G (06) Smart Dongle

Step 1 Install a SIM card. (Skip this step for the Smart Dongle configured with a SIM card.)

Figure 3-10 Installing a SIM card

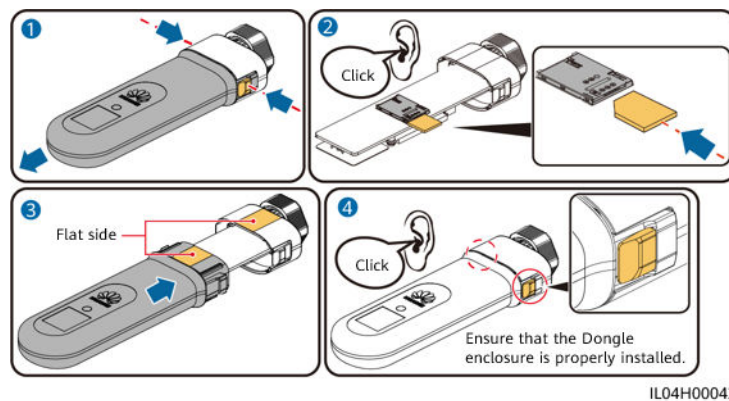

Step 2 Install the Smart Dongle onto the USB port on the master inverter.

Figure 3-11 Installing a Smart Dongle

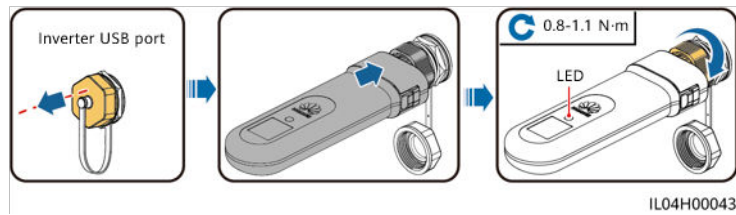

----End

3.4 Installing the WLAN-FE Smart Dongle

WLAN communication

Install the Smart Dongle onto the USB port on the master inverter.

Figure 3-12 Installing a Smart Dongle

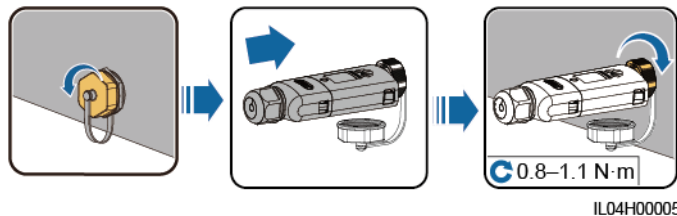

FE Communication

After connecting the FE cable, install the Smart Dongle onto the USB port on the master inverter.

You are advised to use a Cat 5e outdoor shielded network cable (outer diameter < 9 mm; internal resistance ≤ 1.5 ohms/10 m) and shielded RJ45 connectors.

Figure 3-13 Installing a Smart Dongle

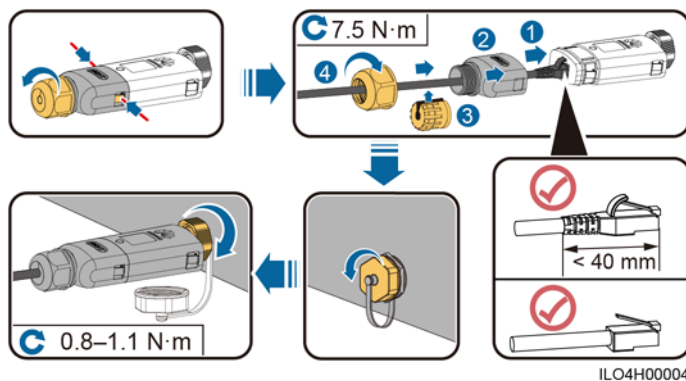

4 System Power-On and Commissioning

DANGER

- Wear personal protective equipment and use dedicated insulated tools to avoid electric shocks or short circuits.
 - Do not use wet cloth to clean exposed copper bars or other conductive parts.
-

WARNING

- Before performing maintenance, power off the equipment, follow the instructions on the delayed discharge label, and wait for a period of time as specified to ensure that the equipment is not energized.
-

NOTICE

Before the equipment is put into operation for the first time, ensure that the parameters are set correctly by professional personnel. Incorrect parameter settings may result in noncompliance with local grid connection requirements and affect the normal operations of the equipment.

4.1 Checking Before Power-On

1. Ensure that the ground cable of the inverter is securely connected.
2. Ensure that the inverter is properly installed and all cables are correctly and reliably connected.
3. Ensure that the Smart Dongle is properly installed.

4.2 Powering On the Inverter

Power on the inverter after cable connections are completed.

Procedure

Step 1 Turn on the AC circuit breaker between the inverter and the power grid.

Step 2 Turn on the DC switch at the bottom of the inverter.

----End

Viewing the LED Indicator Status of the Smart Dongle

Table 4-1 LED indicator status (WLAN Smart Dongle and WLAN-FE Smart Dongle)

Operation	Indicator Color	Indicator Status	Remarks	Description
Installing the Smart Dongle	N/A	Off	Normal	The Smart Dongle is not secured or is not powered on.
	Yellow (blinking green and red simultaneously)	Steady on		The Smart Dongle is secured and powered on.
	Red	Blinking fast (on for 0.2s and then off for 0.2s)		The parameters for connecting to the router are to be set.
	Red	Steady on	Abnormal	Replace the Smart Dongle because it has an internal fault.
	Blinking red and green alternatively	Blinking slowly (red for 1s and then green for 1s)		No communication with the inverter <ul style="list-style-type: none"> Remove and insert the Smart Dongle. Check that the inverter matches the Smart Dongle. Connect the Smart Dongle to another inverter. Check whether the Smart Dongle or the USB port of the inverter is faulty.
Upgrading the Smart Dongle	Blinking red and green alternatively	Blinking fast (red for 0.2s and then green for 0.2s)	Normal	The Smart Dongle is being upgraded locally.
Setting an inverter's connection to a router	Green	Blinking slowly (on for 0.5s and then off for 0.5s)	Normal	Connecting to the router

Operation	Indicator Color	Indicator Status	Remarks	Description
	Red	Blinking fast (on for 0.2s and then off for 0.2s)	Abnormal	Failed to connect to the router. Check whether the parameters for connecting the Smart Dongle to the router are properly set. If not, set the parameters correctly.
Setting parameters in the management system	Green	Steady on	Normal	Successfully connected to the management system.
	Red	Blinking slowly (on for 1s and then off for 1s)	Abnormal	Failed to connect to the management system. Check whether the parameters for connecting inverters to the management system are properly set. If not, set the parameters correctly.
	Green	Blinking fast (on for 0.2s and then off for 0.2s)	Normal	The inverter is communicating with the management system through the Smart Dongle.

Table 4-2 LED indicator status (4G Smart Dongle)

Indicator		Remarks	Description
N/A	Off	Normal	The Smart Dongle is not secured or is not powered on.
Yellow (blinking green and red simultaneously)	Steady on		The Smart Dongle is secured and powered on.
Green	The indicator blinks at intervals of 2s, on for 0.1s and then off for 1.9s.	Normal	Dialing (duration < 1 min)
		Abnormal	If the duration is longer than 1 min, the 4G parameter settings are incorrect. Reset the parameters.
	Blinking slowly (on for 1s and then off for 1s)	Normal	The dial-up connection is set up successfully (duration < 30s).
		Abnormal	If the duration is longer than 30s, the settings of the management system parameters are incorrect. Reset the parameters.
Steady on	Normal	Successfully connected to the management system.	

Indicator		Remarks	Description
	Blinking fast (on for 0.2s and then off for 0.2s)		The inverter is communicating with the management system through the Smart Dongle.
Red	Steady on	Abnormal	Replace the Smart Dongle because it has an internal fault.
	Blinking fast (on for 0.2s and then off for 0.2s)		The Smart Dongle has no SIM card or the SIM card is in poor contact. Check whether the SIM card has been installed or is in good contact. If not, install the SIM card or remove and insert the SIM card.
	Blinking slowly (on for 1s and then off for 1s)		The Smart Dongle fails to connect to the management system because the SIM card has no traffic or the signal strength is poor. If the Smart Dongle is reliably connected, check the SIM card signal through the app. If no signal is received or the signal strength is weak, contact the carrier. Check whether the tariff and traffic of the SIM card are normal. If not, recharge the SIM card or purchase a data package.
Blinking red and green alternatively	Blinking slowly (red for 1s and then green for 1s)		No communication with the inverter <ul style="list-style-type: none"> ● Remove and insert the Smart Dongle. ● Check that the inverter matches the Smart Dongle. ● Connect the Smart Dongle to another inverter. Check whether the Smart Dongle or the USB port of the inverter is faulty.
	Blinking fast (red for 0.2s and then green for 0.2s)	Normal	The Smart Dongle is being upgraded locally.

5 Plant Creation and Commissioning

5.1 Creating a PV Plant

5.1.1 Creating a PV Plant over the App

Prerequisites

- You have downloaded and installed the FusionSolar app which can be obtained by searching for **FusionSolar** in Huawei AppGallery or scanning the QR code.



FusionSolar App

- The inverter is properly powered on and the Smart Dongle communicates with the management system properly.
- You have obtained the login account and password from the installation contractor or Huawei service engineer. If no account or password is available, create an account.

NOTE

- The latest app version is required for device commissioning. You can search for **FusionSolar** in App Store or scanning the QR code to install the app for iOS.
- This section contains a large number of screenshots, which are only used to illustrate the operation method. The PV plant, device model, and parameters in the figures are for reference only.
- The version of the FusionSolar app is 5.7.001. The actual screens may vary.

Procedure

- Step 1** Register an installer account using a mobile number (only in China) or email address. If an installer account exists, skip this step.

Figure 5-1 Registering an account

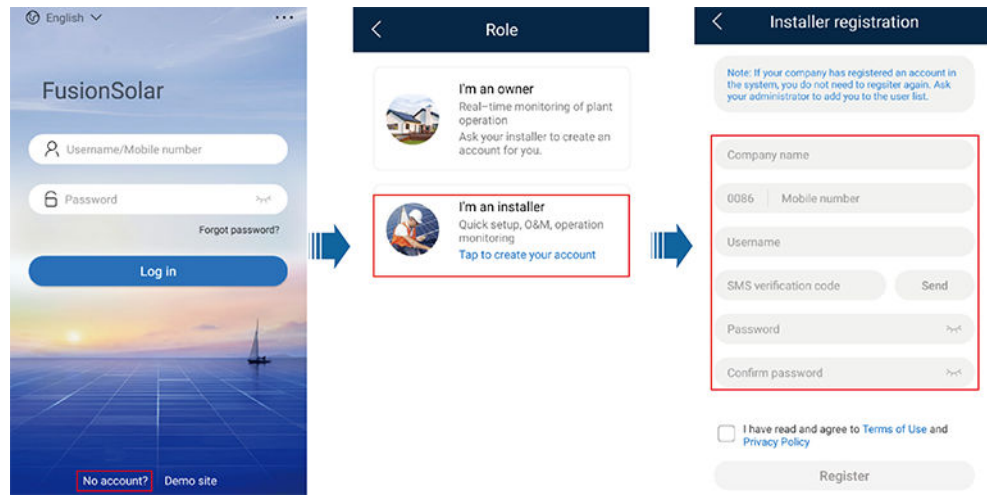

Step 2 Log in to the app using the installer account, and tap **Setup Wizard** to create a PV plant. For details, see the *FusionSolar APP Quick Guide* by scanning the QR code.

NOTE

- To ensure account security, change the password periodically and keep the new password in mind. A password left unchanged for a long period of time may be stolen or cracked. If a password is lost, devices cannot be accessed. In these cases, the user is liable for any loss caused to the PV plant.
- To create multiple installer accounts for a company, log in to the app and create an installer account by choosing **New User**.

Figure 5-2 Creating a PV plant

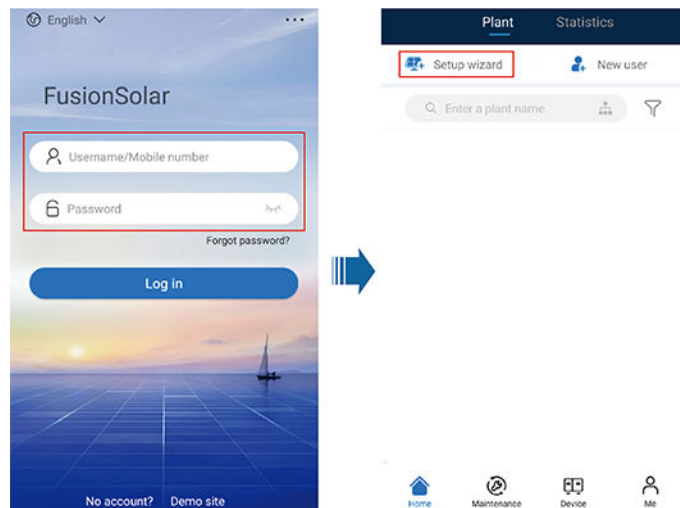

Figure 5-3 FusionSolar APP Quick Guide



----End

5.1.2 Creating a PV Plant over the WebUI

Prerequisites

- You have matched the devices with the PV plant with the PV plant with the help of the installation contractor.
- The inverter and Smart Dongle have been powered on and communicates properly with the management system.
- You have obtained the login account and password from the installation contractor or Huawei service engineer. If no account or password is available, create an account.

Figure 5-4 Procedure for creating a PV plant

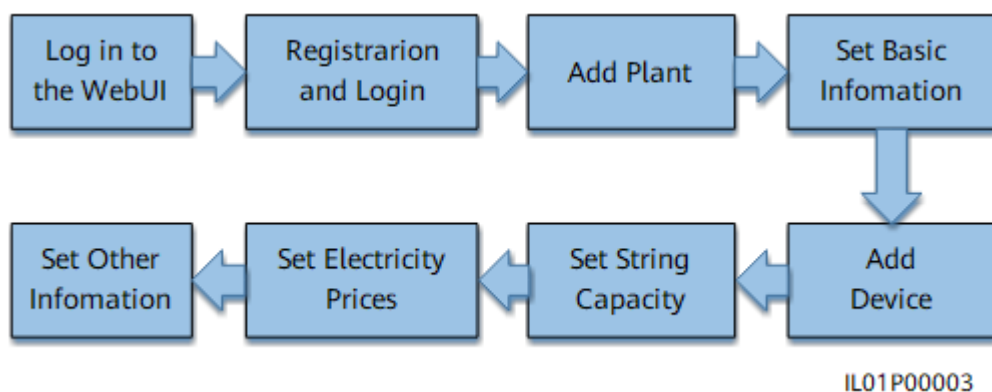

Procedure

Step 1 Enter the management system address in the address box of a browser: <https://intl.fusionsolar.huawei.com>.

NOTE

- Browser: Chrome 67, Safari 9.0, Internet Explorer 11, or a later version is recommended.
- The software version corresponding to the user interface (UI) snapshots is SmartPVMS V500R007C00CP2101. The UIs may vary with software versions and are for reference only.

Step 2 If you have obtained the login account and password from the installation contractor or Huawei service engineer, enter the account and password, and click **Log In** to go to the home page. If you have not created an account, click **Installer Registration**, fill in the registration information, and activate the account with the email verification code sent to you.

Figure 5-5 Login page

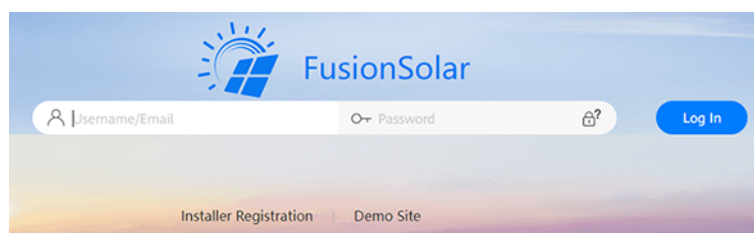

Figure 5-6 Registering an account

Installer Registration

Note:
If your company has registered an account in the system, you do not need to register again.
Ask your administrator to add you to the user list.

* Company name:

* Mobile number:

* Username:

* Password:

* Confirm password:

* SMS verification code:

I agree to [Terms of Use](#) and I have read [Privacy Policy](#).

Step 3 Add Plant.

- Method 1: On the home page, click **Add Plant**.

Figure 5-7 Creating a PV plant (method 1)

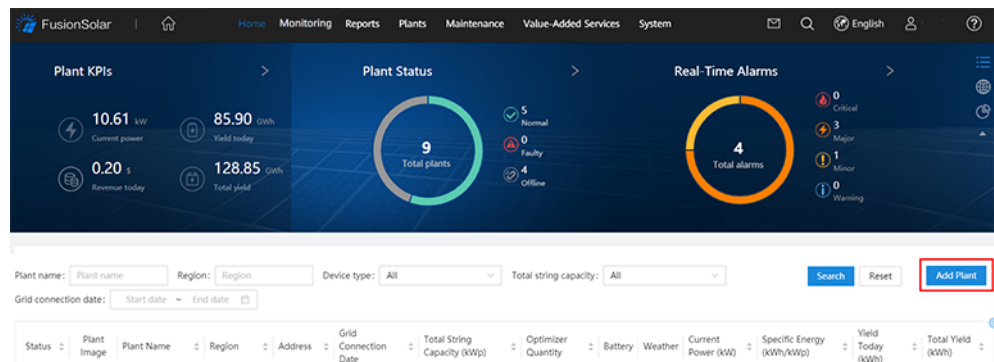

- Method 2: On the home page, click **Plants**, choose **Plant Management** under **Plant**, and click **Add Plant**.

Figure 5-8 Creating a PV plant (method 2)

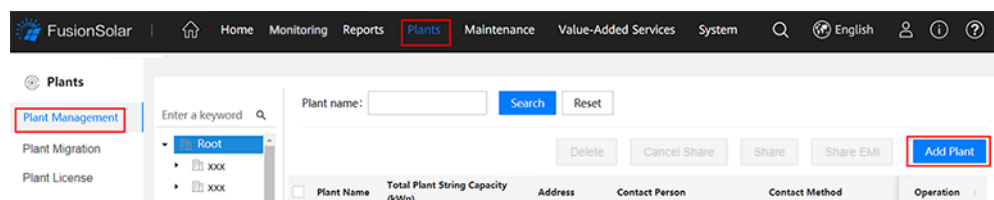

Step 4 Fill in the basic information about the PV plant as required and click Next.

Figure 5-9 Basic information of the PV plant

The screenshot shows the 'Add Plant' form with the 'Set Basic Info' step selected. The form contains the following fields and elements:

- Company:** A dropdown menu with a red asterisk indicating it is mandatory.
- Plant name:** A text input field with a red asterisk.
- Grid connection date:** A date picker with a red asterisk.
- Contact person:** A text input field.
- Contact method:** A text input field with a placeholder 'Enter a phone number or an email address.' and a red asterisk.
- Authorization:** A checkbox labeled 'User's authorization obtained' with a red asterisk. Below it is a warning: 'If the content you entered involves third-party personal information, obtain authorization in advance.'
- Buttons:** 'Cancel' and 'Next' buttons at the bottom right.

Table 5-1 Description of basic information (* means mandatory fields)

Parameter	Description
Company*	Company to which the new PV plant belongs.
Plant name*	Name of the new PV plant.
Grid connection time*	Start date of the safe operation of the PV plant.
Contact Person	PV plant contact who facilitates problem handling. You are advised to set this parameter.
Contact method	Contact information which facilitates problem handling. You are advised to set this parameter.

Step 5 On the **Add Devices** tab page, set the connected devices for the PV plant.

1. Manually enter the SN of the Smart Dongle and click the blank area of **Device type**. The system automatically displays the device name and model. The affiliated inverters and power meter are automatically added. Click + on the left of the SN to expand the device information. (The + icon becomes the – icon after the information is expanded.) Then, check whether the connected devices are correct.

Figure 5-10 Entering the device SN

The screenshot shows the 'Add Plant' form with the 'Add Devices' step selected. The 'Add' button is highlighted. Below the main form, a summary bar shows:

- SN:** xxxxxxxxxxxx
- Device type:** Dongle
- Device model:** SDongleA

Buttons for 'Refresh', 'Add', and 'Delete' are visible.

Step 6 Click **Next** to go to the **Set String Capacity** tab page.

1. Fill **Total plant string capacity (kWp)** (Total rated active power of the plant generator set) as required. In the device list, select one or more devices to be configured and click **Set String Capacity**. The **Set String Capacity** dialog box is displayed.

Figure 5-11 Setting string capacity

The screenshot shows the 'Add Plant' dialog box with the 'Set String Capacity' tab selected. A progress bar at the top indicates the current step. The 'Total plant string capacity (kWp)' field is set to 30. Below this is a table of devices:

<input type="checkbox"/>	Device Name	Device Type	Device Model	SN	String Capacity (kWp)
<input checked="" type="checkbox"/>	HV2080055916	Inverter	SUN2000-10KTL-M1	XXXXXXXXXX	3.334

The 'Set String Capacity' button is highlighted with a red box.

2. Verify the number of PV strings and the string capacity, and click **OK**.

Figure 5-12 Verifying the number of PV strings and the string capacity

The screenshot shows the 'Set String Capacity' dialog box. The 'Batch apply' checkbox is checked. The 'String quantity' field is set to 2. The 'PV1 capacity' and 'PV2 capacity' fields are both set to 3000 Wp. The 'OK' button is highlighted.

NOTE



If **Batch apply** is selected, the capacity of other PV strings to be configured is automatically set to the same value as PV1 after PV1 capacity is configured.

- Step 7** Click **Next**. On the displayed **Set Electricity Prices** tab page, set the date range, time period, and electricity price.

Figure 5-13 Adding time-based prices

The screenshot shows the 'Add Plant' dialog box with the 'Set Electricity Prices' tab selected. The 'Purchase Price' section is active. The 'Date range' is set to 01-01 to 12-31. The 'Start time' is 00:00:00, the 'End time' is 24:00:00, and the 'Price' is 1 CNY/kWh. The 'Add' button is highlighted.

 NOTE

- Click **Add** to add a date range. Multiple date ranges cannot overlap and must cover a full year.
- Click  to add a time period and price. Multiple time periods cannot overlap and must cover a full year.
- Click **Delete** to delete a time-based price.
- Click  to delete a date range.

Step 8 Click **Next** to go to the **Set Other Info** tab page. Set other information about the PV plant, including **Plant image**, **Address**, **Start time of safe running**, **Plant overview**, and **Plant time zone** of the PV plant. **Start time of safe running** refers to the day when the PV plant starts to generate electricity normally. It is mainly used to calculate the safe running days of the PV plant.

Figure 5-14 Other information

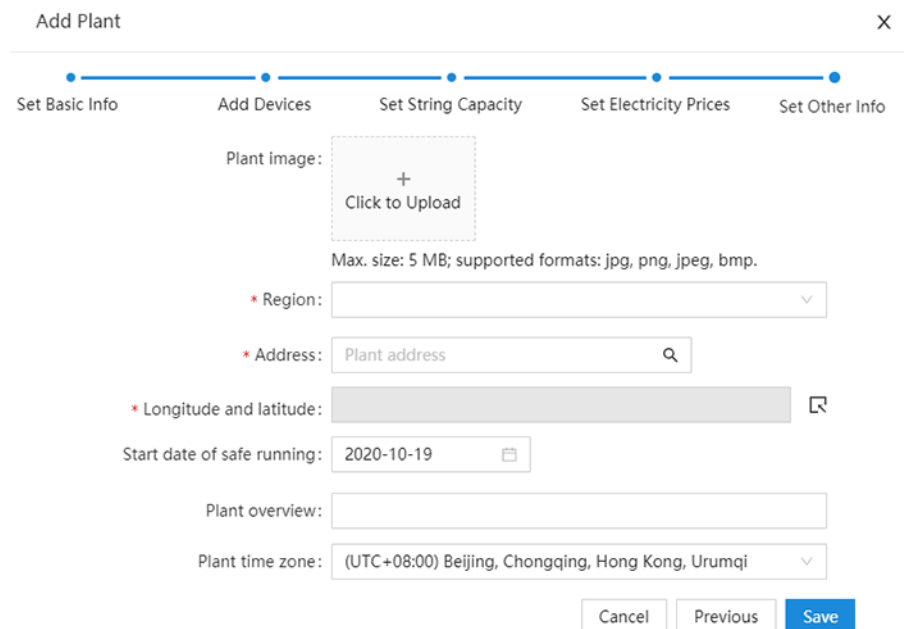

Step 9 Click **Save**. In the displayed dialog box, click **OK**. The PV plant is created successfully.

----End

Follow-up Procedure

- Modifying PV plant information: In the PV plant list, click **Modify** for the PV plant to be modified.
- Deleting a PV plant: In the PV plant list, select one or more PV plants to be deleted and click **Delete**.

5.2 Setting Grid-tied Control Parameters

5.2.1 Setting Parameters over the App

Prerequisites

- The FusionSolar app is recommended when the inverter is connected to the FusionSolar Smart PV Management System. The SUN2000 app is recommended when the inverter is connected to other management systems.
- You have downloaded and installed the FusionSolar app which can be obtained by searching for **FusionSolar** in Huawei AppGallery or scanning the QR code.



FusionSolar App

- SUN2000 APP: Search for "SUN2000" in Huawei AppGallery, download the latest installation package, and install the SUN2000 app by following the instructions.

NOTE

- In areas (such as the UK) where the FusionSolar app is not available, or when a third-party management system is used, only the SUN2000 app can be used for commissioning. This document uses the FusionSolar app as an example to describe the commissioning method. For the SUN2000 app, perform operations as required.
- The SUN2000 app version should be 3.2.00.005 (Android) or later.

Procedure

- Step 1** Run the FusionSolar app and go to the **Device commissioning** screen. (Perform this step only for the FusionSolar app.)

Figure 5-15 Device commissioning

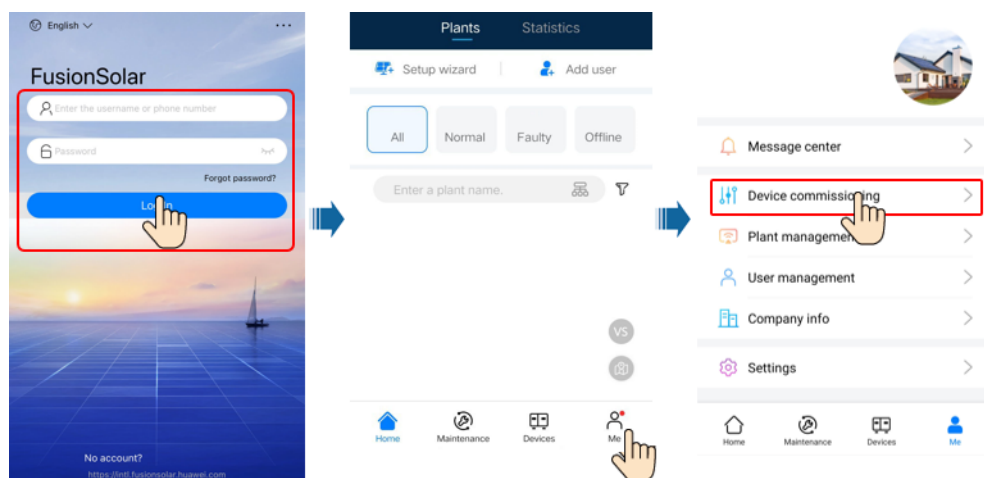

- Step 2** Connect to the inverter

Figure 5-16 Connecting to the inverter

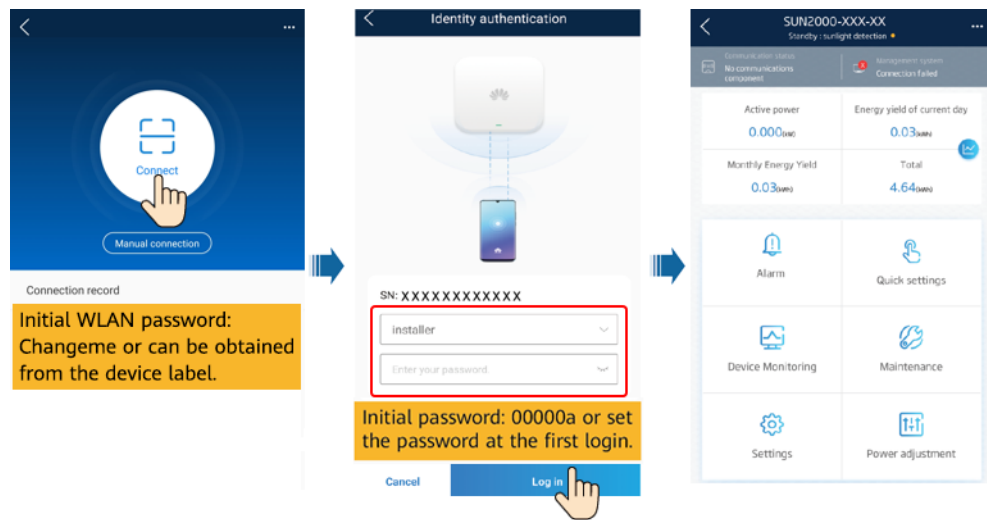

NOTE

- Code scanning: Tap **Connect** to access the scanning screen, place the QR code or bar code of the solar inverter in the scan frame. The device will be automatically connected after the code is identified.
- During the login, if five consecutive invalid password entries are made (the interval between two consecutive entries is less than 2 minutes), the account will be locked for 10 minutes. The password should consist of six characters.
- To ensure account security, change the password periodically and keep the new password in mind. A password left unchanged for a long period of time may be stolen or cracked. If a password is lost, devices cannot be accessed. In these cases, the user is liable for any loss caused to the PV plant.

Step 3 Set grid-tied control parameters.

NOTE

To set **Grid-tied point control**, you need to enter the inverter login password. For details about the inverter login password, see the section about connecting to the inverter.

Figure 5-17 Parameter settings

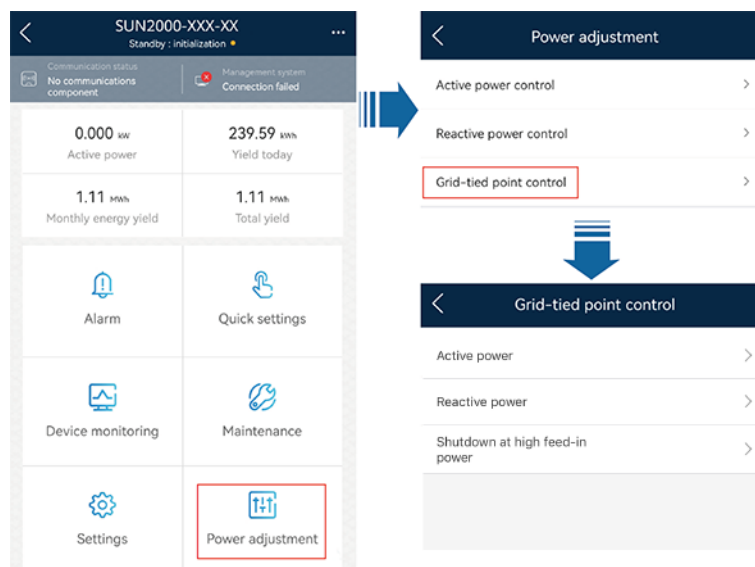

Table 5-2 Control mode

Parameter Name			Description
Active power	Unlimited	N/A	If this parameter is set to Unlimited , the inverter output power is not limited and the inverter can feed its rated power to the power grid.
	Grid connection with zero power	Closed-loop controller	<ul style="list-style-type: none"> For a single inverter: When the Smart Dongle is connected, set Closed-loop controller to Inverter. When the inverter is directly connected, Closed-loop controller to Inverter. For multiple inverters, Closed-loop controller can only be set to SDongle/SmartLogger.
		Limitation mode	<ul style="list-style-type: none"> Total power indicates export limitation of the total power at the grid-connection point. (When a single-phase meter is connected, only the Total power limitation mode can be selected.) Single-phase power indicates export limitation of the power in each phase at the grid-connection point.
		Power adjustment period	Specifies the shortest interval for a single export limitation adjustment.
		Power raising threshold	Specifies the dead zone for adjusting the inverter output power. If the power fluctuates within the power control hysteresis, the power is not adjusted.
		Communication disconnection fail-safe	In the inverter export limitation scenario, if this parameter is set to Enable , the inverter will derate according to the active power derating percentage when the communication between the inverter and the Smart Dongle is disconnected for a period longer than Communication disconnection detection time .
		Communication disconnection detection time	Specifies the time for determining the communication disconnection between the inverter and the Smart Dongle. This parameter is displayed when Communication disconnection fail-safe is set to Enable .
		Active power output limit for fail-safe	Specifies the derating value of the inverter active power by percentage. If the Smart Dongle does not detect any power meter data or the communication between the Smart Dongle and the inverter is disconnected, the Smart Dongle delivers the derating value of the inverter active power by percentage.

Parameter Name		Description
Grid connection with limited power (kW)	Closed-loop controller	<ul style="list-style-type: none"> For a single inverter: When the Smart Dongle is connected, set Closed-loop controller to Inverter. When the inverter is directly connected, Closed-loop controller to Inverter. For multiple inverters, Closed-loop controller can only be set to SDongle/SmartLogger.
	Limitation mode	<ul style="list-style-type: none"> Total power indicates export limitation of the total power at the grid-connection point. (When a single-phase meter is connected, only the Total power limitation mode can be selected.) Single-phase power indicates export limitation of the power in each phase at the grid-connection point.
	Maximum grid feed-in power (kW)	Specifies the maximum active power transmitted from the grid-tied point to the power grid.
	Power adjustment period	Specifies the shortest interval for a single export limitation adjustment.
	Maximum protection time	<ul style="list-style-type: none"> Specifies the time for detecting power meter data. If the Smart Dongle does not detect any power meter data within the preset time, the Smart Dongle delivers the preset value of the Fail-safe power threshold to the inverter for protection. The recommended value is 5s or greater.
	Power raising threshold	Specifies the dead zone for adjusting the inverter output power. If the power fluctuates within the power control hysteresis, the power is not adjusted.
	Communication disconnection fail-safe	In the inverter export limitation scenario, if this parameter is set to Enable , the inverter will derate according to the active power derating percentage when the communication between the inverter and the Smart Dongle is disconnected for a period longer than Communication disconnection detection time .
	Communication disconnection detection time	Specifies the time for determining the communication disconnection between the inverter and the Smart Dongle. This parameter is displayed when Communication disconnection fail-safe is set to Enable .

Parameter Name		Description
	Active power output limit for fail-safe	Specifies the derating value of the inverter active power by percentage. If the Smart Dongle does not detect any power meter data or the communication between the Smart Dongle and the inverter is disconnected, the Smart Dongle delivers the derating value of the inverter active power by percentage.
Grid connection with limited power (%)	Closed-loop controller	<ul style="list-style-type: none"> For a single inverter: When the Smart Dongle is connected, set Closed-loop controller to Inverter. When the inverter is directly connected, Closed-loop controller to Inverter. For multiple inverters, Closed-loop controller can only be set to SDongle/SmartLogger.
	Limitation mode	<ul style="list-style-type: none"> Total power indicates export limitation of the total power at the grid-connection point. (When a single-phase meter is connected, only the Total power limitation mode can be selected.) Single-phase power indicates export limitation of the power in each phase at the grid-connection point.
	PV plant capacity	Specifies the total maximum active power in the inverter cascading scenario.
	Maximum grid feed-in power (%)	Specifies the percentage of the maximum active power of the grid-tied point to the PV plant capacity.
	Power adjustment period	Specifies the shortest interval for a single export limitation adjustment.
	Maximum protection time	<ul style="list-style-type: none"> Specifies the time for detecting power meter data. If the Smart Dongle does not detect any power meter data within the preset time, the Smart Dongle delivers the preset value of the Fail-safe power threshold to the inverter for protection. The recommended value is 5s or greater.
	Power raising threshold	Specifies the dead zone for adjusting the inverter output power. If the power fluctuates within the power control hysteresis, the power is not adjusted.
	Communication disconnection fail-safe	In the inverter export limitation scenario, if this parameter is set to Enable , the inverter will derate according to the active power derating percentage when the communication between the inverter and the Smart Dongle is disconnected for a period longer than Communication disconnection detection time .

Parameter Name		Description
	Communication disconnection detection time	Specifies the time for determining the communication disconnection between the inverter and the Smart Dongle. This parameter is displayed when Communication disconnection fail-safe is set to Enable .
	Active power output limit for fail-safe	Specifies the derating value of the inverter active power by percentage. If the Smart Dongle does not detect any power meter data or the communication between the Smart Dongle and the inverter is disconnected, the Smart Dongle delivers the derating value of the inverter active power by percentage.
Shutdown at high feed-in power ^a	Shutdown at high feed-in power	<ul style="list-style-type: none"> The default value is Disable. If this parameter is set to Enable, the inverter shuts down for protection when the grid-connection point power exceeds the threshold and remains in this condition for the specified time threshold.
	Upper feed-in power threshold for inverter shutdown (kW)	<ul style="list-style-type: none"> The default value is 0. This parameter specifies the power threshold of the grid-connection point for triggering inverter shutdown.
	High feed-in power duration threshold for triggering inverter shutdown (s)	<p>The default value is 20. This parameter specifies the duration threshold of high feed-in power for triggering inverter shutdown.</p> <ul style="list-style-type: none"> When High feed-in power duration threshold for triggering inverter shutdown is set to 5, Shutdown at high feed-in power takes precedence. When High feed-in power duration threshold for triggering inverter shutdown is set to 20, Grid connection with limited power takes precedence (when Active power control is set to Grid connection with limited power).
Note a: This parameter is supported only for the AS4777 grid code.		

----End

5.2.2 Setting Parameters over the WebUI

Prerequisites

- You have matched the devices with the PV plant with the PV plant with the help of the installation contractor.
- The inverter and Smart Dongle have been powered on and communicates properly with the management system.

- You have obtained the login account and password from the installation contractor or Huawei service engineer. If no account or password is available, create an account.

Procedure

Step 1 Enter the management system address in the address box of a browser: <https://intl.fusionsolar.huawei.com>.

NOTE

- Browser: Chrome 67, Safari 9.0, Internet Explorer 11, or a later version is recommended.
- The software version corresponding to the user interface (UI) snapshots is SmartPVMS V500R007C00CP2101. The UIs may vary with software versions and are for reference only.

Step 2 If you have obtained the login account and password from the installation contractor or Huawei service engineer, enter the account and password, and click **Log In** to go to the home page. If you have not created an account, click **Installer Registration**, fill in the registration information, and activate the account with the email verification code sent to you.

Figure 5-18 Login page

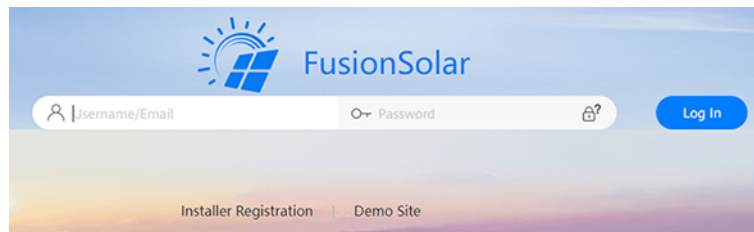

Figure 5-19 Registering an account

Installer Registration

Note:
If your company has registered an account in the system, you do not need to register again.
Ask your administrator to add you to the user list.

* Company name:

* Mobile number:

* Username:

* Password:

* Confirm password:

* SMS verification code:

I agree to [Terms of Use](#) and I have read [Privacy Policy](#).

Step 3 On the **Home** page, click the plant name to access the plant page. Choose **Device Management**, select Dongle, and click **Set Parameters**.

Figure 5-20 Setting export limitation 1

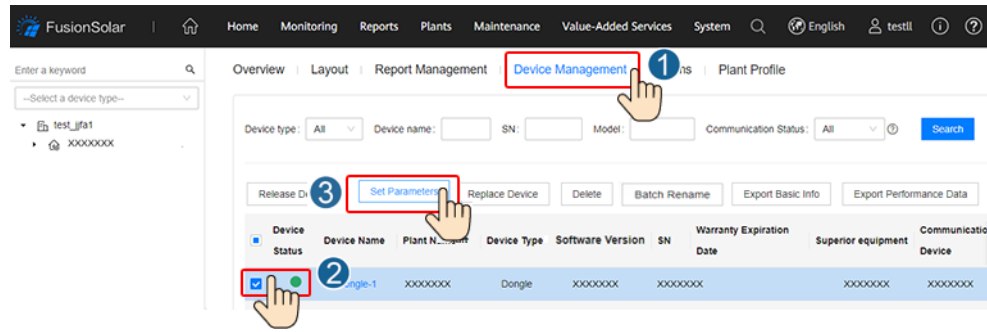

Step 4 Choose **Active Power Control** and set related parameters.

Figure 5-21 Setting export limitation 2

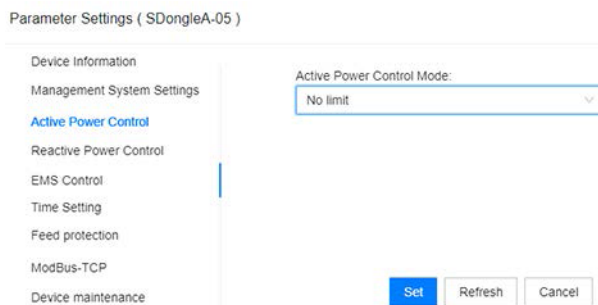

Table 5-3 Active power control mode

Parameter		Description
Unlimited	N/A	If this parameter is set to Unlimited , the inverter output power is not limited and the inverter can feed its rated power to the power grid.
Grid connection with zero power	Closed-loop controller	<ul style="list-style-type: none"> For a single inverter: When the Smart Dongle is connected, set Closed-loop controller to Inverter. When the inverter is directly connected, Closed-loop controller to Inverter. For multiple inverters, Closed-loop controller can only be set to SDongle/SmartLogger.
	Limitation mode	<ul style="list-style-type: none"> Total power indicates export limitation of the total power at the grid-connection point. (When a single-phase meter is connected, only the Total power limitation mode can be selected.) Single-phase power indicates export limitation of the power in each phase at the grid-connection point.
	Power adjustment period	Specifies the shortest interval for a single export limitation adjustment.

Parameter		Description
	Maximum protection time	<ul style="list-style-type: none"> Specifies the time for detecting power meter data. If the Smart Dongle does not detect any power meter data within the preset time, the Smart Dongle delivers the preset value of the Fail-safe power threshold to the inverter for protection. The recommended value is 5s or greater.
	Power raising threshold	Specifies the dead zone for adjusting the inverter output power. If the power fluctuates within the power control hysteresis, the power is not adjusted.
	Fail-safe power threshold	Specifies the derating value of the inverter active power by percentage. If the Smart Dongle does not detect any power meter data or the communication between the Smart Dongle and the inverter is disconnected, the Smart Dongle delivers the derating value of the inverter active power by percentage.
Grid connection with limited power (kW)	Closed-loop controller	<ul style="list-style-type: none"> For a single inverter: When the Smart Dongle is connected, set Closed-loop controller to Inverter. When the inverter is directly connected, Closed-loop controller to Inverter. For multiple inverters, Closed-loop controller can only be set to SDongle/SmartLogger.
	Limitation mode	<ul style="list-style-type: none"> Total power indicates export limitation of the total power at the grid-connection point. (When a single-phase meter is connected, only the Total power limitation mode can be selected.) Single-phase power indicates export limitation of the power in each phase at the grid-connection point.
	PV plant capacity	Specifies the total maximum active power in the inverter cascading scenario.
	Maximum grid feed-in power (kW)	Specifies the maximum active power transmitted from the grid-tied point to the power grid.
	Power adjustment period	Specifies the shortest interval for a single export limitation adjustment.
	Maximum protection time	<ul style="list-style-type: none"> Specifies the time for detecting power meter data. If the Smart Dongle does not detect any power meter data within the preset time, the Smart Dongle delivers the preset value of the Fail-safe power threshold to the inverter for protection. The recommended value is 5s or greater.
	Power raising threshold	Specifies the dead zone for adjusting the inverter output power. If the power fluctuates within the power control hysteresis, the power is not adjusted.

Parameter		Description
	Fail-safe power threshold	Specifies the derating value of the inverter active power by percentage. If the Smart Dongle does not detect any power meter data or the communication between the Smart Dongle and the inverter is disconnected, the Smart Dongle delivers the derating value of the inverter active power by percentage.
Grid connection with limited power (%)	Closed-loop controller	<ul style="list-style-type: none"> For a single inverter: When the Smart Dongle is connected, set Closed-loop controller to Inverter. When the inverter is directly connected, Closed-loop controller to Inverter. For multiple inverters, Closed-loop controller can only be set to SDongle/SmartLogger.
	Limitation mode	<ul style="list-style-type: none"> Total power indicates export limitation of the total power at the grid-connection point. (When a single-phase meter is connected, only the Total power limitation mode can be selected.) Single-phase power indicates export limitation of the power in each phase at the grid-connection point.
	PV plant capacity	Specifies the total maximum active power in the inverter cascading scenario.
	Maximum grid feed-in power (%)	Specifies the percentage of the maximum active power of the grid-tied point to the PV plant capacity.
	Power adjustment period	Specifies the shortest interval for a single export limitation adjustment.
	Maximum protection time	<ul style="list-style-type: none"> Specifies the time for detecting power meter data. If the Smart Dongle does not detect any power meter data within the preset time, the Smart Dongle delivers the preset value of the Fail-safe power threshold to the inverter for protection. The recommended value is 5s or greater.
	Power raising threshold	Specifies the dead zone for adjusting the inverter output power. If the power fluctuates within the power control hysteresis, the power is not adjusted.
	Fail-safe power threshold	Specifies the derating value of the inverter active power by percentage. If the Smart Dongle does not detect any power meter data or the communication between the Smart Dongle and the inverter is disconnected, the Smart Dongle delivers the derating value of the inverter active power by percentage.

----End

5.3 Third-Party Management System Settings (Connecting to Two Management Systems)

Prerequisites

- The inverter connects to a third-party management system and the Huawei management system.
- You have downloaded and installed the FusionSolar app which can be obtained by searching for **FusionSolar** in Huawei AppGallery or scanning the QR code.



FusionSolar App

- SUN2000 APP: Search for "SUN2000" in Huawei AppGallery, download the latest installation package, and install the SUN2000 app by following the instructions.

NOTE

- Only SDongleB-06 and SDongleA-05 (BOM number: 02312QMV-004) can connect to a third-party management system.
- The app version must be 6.24.00.006 or later.

Method 1: Connecting to the Inverter Built-in WLAN to Set Third-Party Management System Parameters

NOTE

Only the SUN2000-(12KTL-25KTL)-M5 and SUN600-(15KTL-25KTL)-ZHM0 allow users to connect to the inverter built-in WLAN to set third-party management system parameters.

- Step 1** Run the FusionSolar app and go to the **Device commissioning** screen. (Perform this step only for the FusionSolar app.)

Figure 5-22 Device commissioning

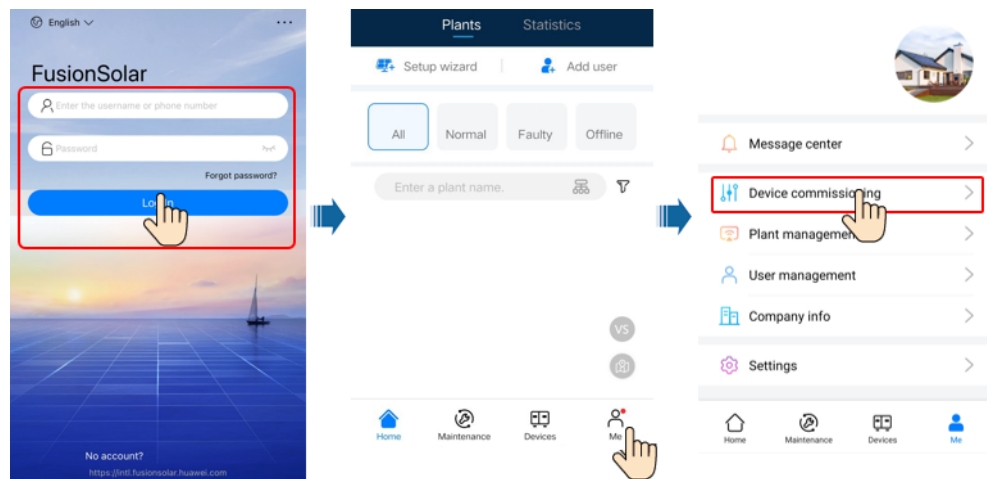

Step 2 Connect to the inverter.

Figure 5-23 Connecting to the inverter

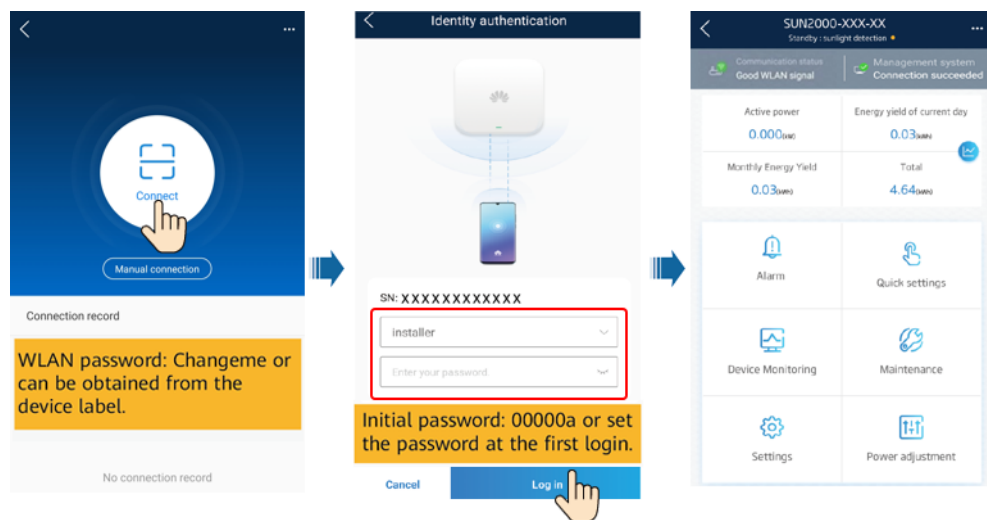

NOTE

- Code scanning: Tap **Connect** to access the scanning screen, place the QR code or bar code of the solar inverter in the scan frame. The device will be automatically connected after the code is identified.
- During the login, if five consecutive invalid password entries are made (the interval between two consecutive entries is less than 2 minutes), the account will be locked for 10 minutes. The password should consist of six characters.
- To ensure account security, change the password periodically and keep the new password in mind. A password left unchanged for a long period of time may be stolen or cracked. If a password is lost, devices cannot be accessed. In these cases, the user is liable for any loss caused to the PV plant.

Step 3 Setting the third-party management parameters

Figure 5-24 Parameter settings

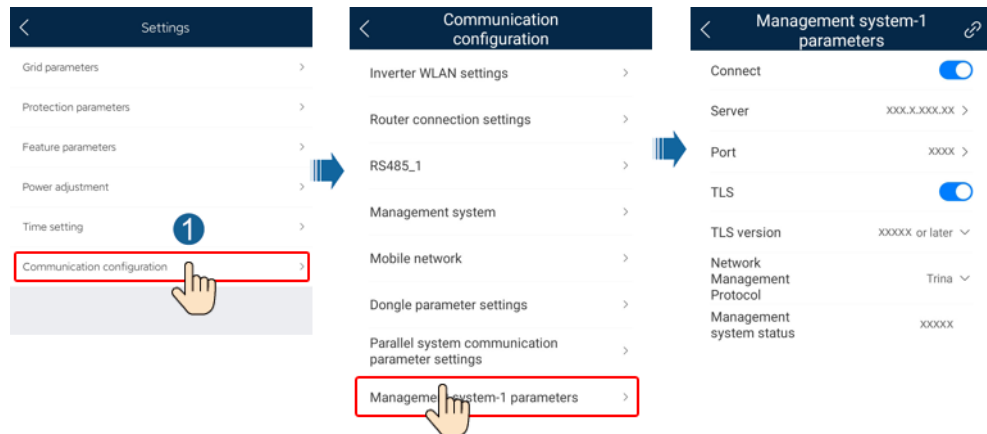

Table 5-4 Parameter settings

Parameter	Description	Value Range
Connect	<ul style="list-style-type: none"> The default value is Disable, meaning that a third-party management system is not connected. When this parameter is set to Enable, a third-party management system can be connected. 	<ul style="list-style-type: none"> Disable Enable
Server	Domain name or IP address.	-
Port	Server port.	[0, 65535]
TLS	<ul style="list-style-type: none"> If the third-party management system uses the TLS encryption protocol, set this parameter to Enable and select a most secure version supported by the third-party management system. If the third-party management system does not use the TLS encryption protocol, set this parameter to Disable. 	<ul style="list-style-type: none"> Disable Enable
TLS version	Select a version based on the TLS version of the third-party management system.	<ul style="list-style-type: none"> TLS 1.0 or later TLS 1.1 or later TLS 1.2 or later TLS 1.3
Network Management Protocol	The default value is standard Modbus.	Modbus

----End

Method 2: Logging In to the FusionSolar Smart PV Management System to Set Third-Party Management System Parameters

NOTE

Only the SUN2000-(12KTL-25KTL)-M5, SUN600-(15KTL-25KTL)-ZHM0, SUN2000-(2KTL-6KTL)-L1, SUN2000-(8KTL-20KTL)-M2, and SUN2000-(5KTL-12KTL)-M1 allow users to

log in to the FusionSolar Smart PV Management System to set third-party management system parameters.

- Log in to the FusionSolar app and tap the plant name on the **Home** screen to access the plant screen. Choose **Devices**, select the target SDongle, and choose **Parameter settings**. Set the parameters as prompted.

Figure 5-25 Setting the third-party management parameters

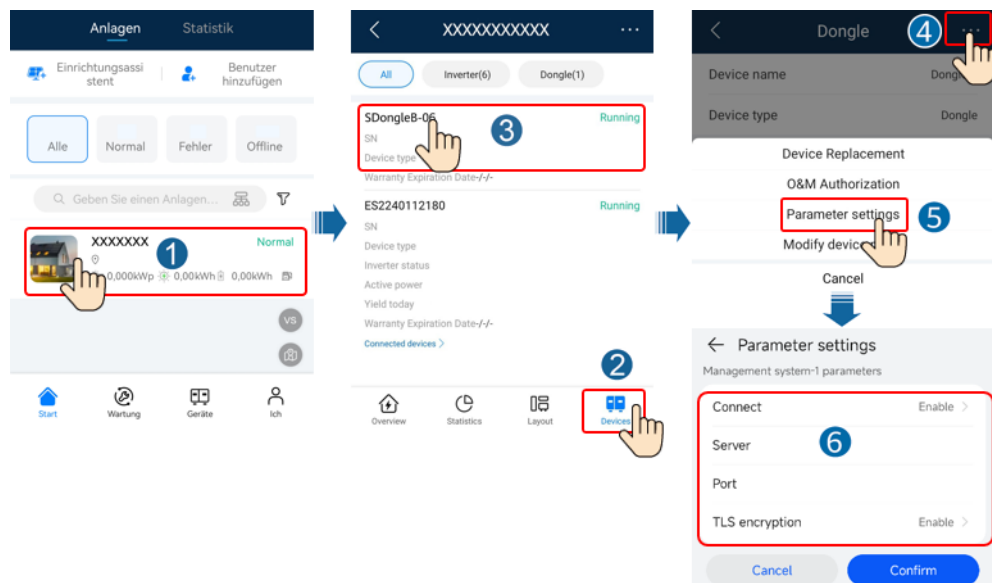

- Log in to <https://intl.fusionsolar.huawei.com> to access the WebUI of the FusionSolar Smart PV Management System. On the **Home** page, click the plant name to access the plant page. Choose **Device Management**, select the target SDongle, click **Set Parameter**. Set the parameters as prompted.

Figure 5-26 Setting the third-party management parameters

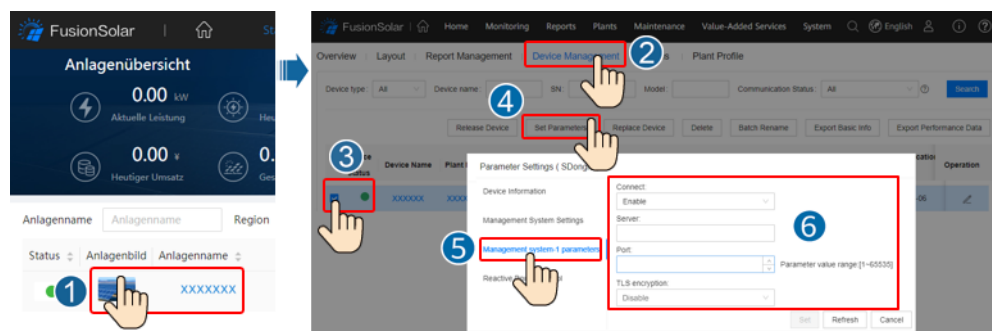

Table 5-5 Parameter settings

Parameter	Description	Value Range
Connect	<ul style="list-style-type: none"> The default value is Disable, meaning that a third-party management system is not connected. When this parameter is set to Enable, a third-party management system can be connected. 	<ul style="list-style-type: none"> Disable Enable
Server	Domain name or IP address.	-
Port	Server port.	[0, 65535]
TLS encryption	<ul style="list-style-type: none"> If the third-party management system uses the TLS encryption protocol, set this parameter to Enable and select a most secure version supported by the third-party management system. If the third-party management system does not use the TLS encryption protocol, set this parameter to Disable. 	<ul style="list-style-type: none"> Disable Enable

5.4 Setting Parameters and Exporting Logs Through the WLAN of the Smart Dongle

Procedure

Step 1 Run the FusionSolar app and go to the **Device commissioning** screen. (Perform this step only for the FusionSolar app.)

Figure 5-27 Device commissioning

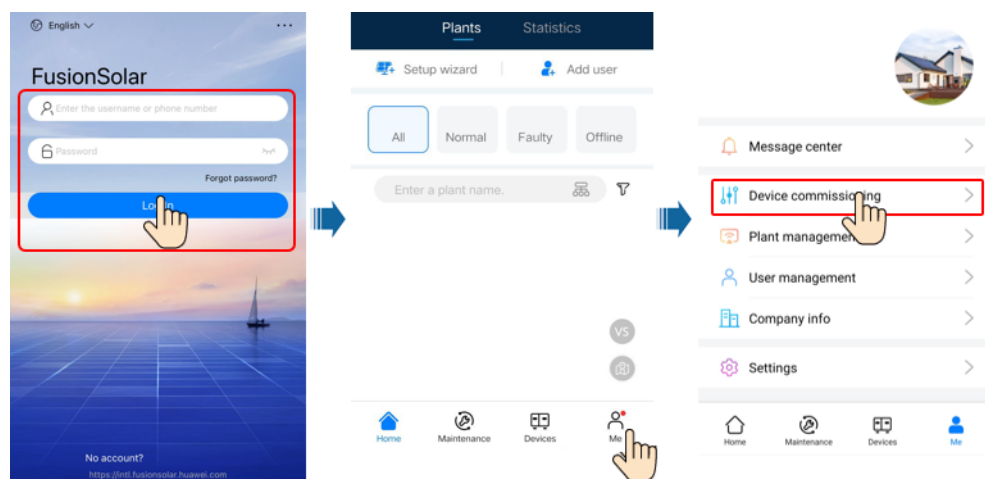

Step 2 Connect to the Smart Dongle to set parameters and export logs. For details, see the Smart Dongle section in the *FusionSolar App, SUN2000 App Device Commissioning Manual*. You can scan the following QR code to obtain the document.

Figure 5-28 Connecting to the Smart Dongle

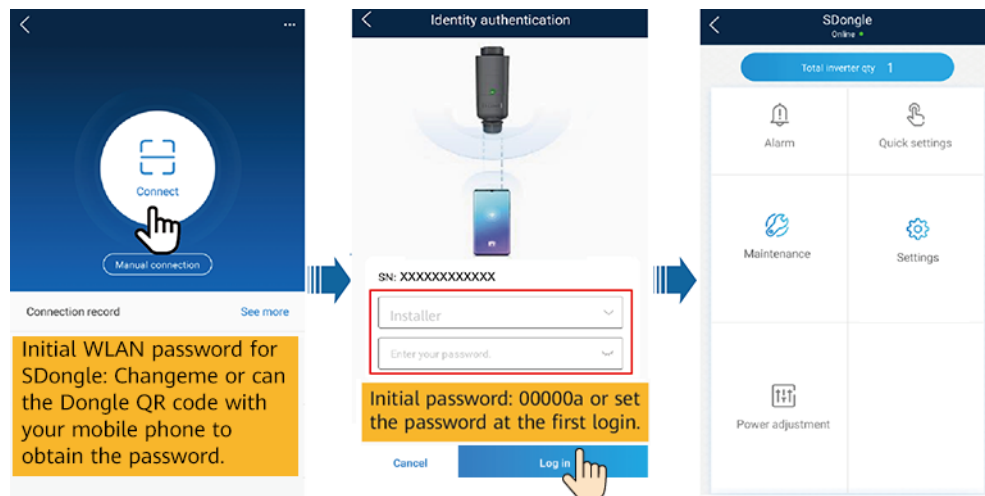

Figure 5-29 FusionSolar App, SUN2000 App Device Commissioning Manual



NOTE

- Code scanning: Tap **Connect** to access the scanning screen, place the QR code or bar code of the solar inverter in the scan frame. The device will be automatically connected after the code is identified.
- If you enter wrong login passwords for **installer** for five consecutive times and the interval between two attempts is within 2 minutes, your account will be locked. Log in to the app again after 5 minutes.
- Use the initial password upon the first Log-in and change it immediately after login. To ensure account security, change the password periodically and keep the new password in mind. Not changing the initial password may cause password disclosure. A password left unchanged for a long period of time may be stolen or cracked. If a password is lost, devices cannot be accessed. In these cases, the user is liable for any loss caused to the PV plant.
- Only SDongleA-05 or SDongleB-06 supports this upgrade mode.
- The screenshots are for reference only. The actual screens may vary.

----End

6 Maintenance

6.1 Modifying Inverter Communications Parameters

Prerequisites

- The FusionSolar app is recommended when the inverter is connected to the FusionSolar Smart PV Management System. The SUN2000 app is recommended when the inverter is connected to other management systems.
- You have downloaded and installed the FusionSolar app which can be obtained by searching for **FusionSolar** in Huawei AppGallery or scanning the QR code.



FusionSolar App

- SUN2000 APP: Search for "SUN2000" in Huawei AppGallery, download the latest installation package, and install the SUN2000 app by following the instructions.

NOTE

- In areas (such as the UK) where the FusionSolar app is not available, or when a third-party management system is used, only the SUN2000 app can be used for commissioning. This document uses the FusionSolar app as an example to describe the commissioning method. For the SUN2000 app, perform operations as required.
- The SUN2000 app version should be 3.2.00.005 (Android) or later.

6.1.1 WLAN Communication Networking

Step 1 Run the FusionSolar app and go to the **Device commissioning** screen. (Perform this step only for the FusionSolar app.)

Figure 6-1 Device commissioning

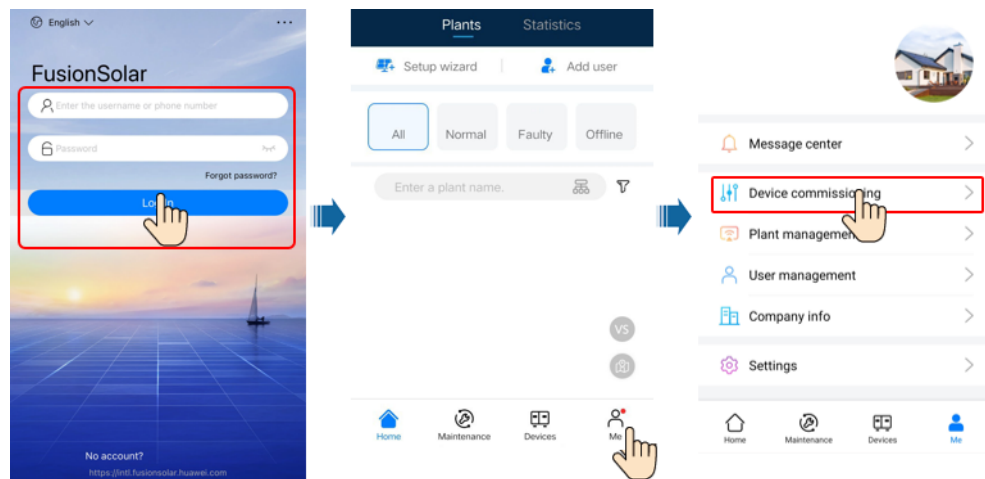

Step 2 Connect to the inverter.

Figure 6-2 Connecting to the inverter

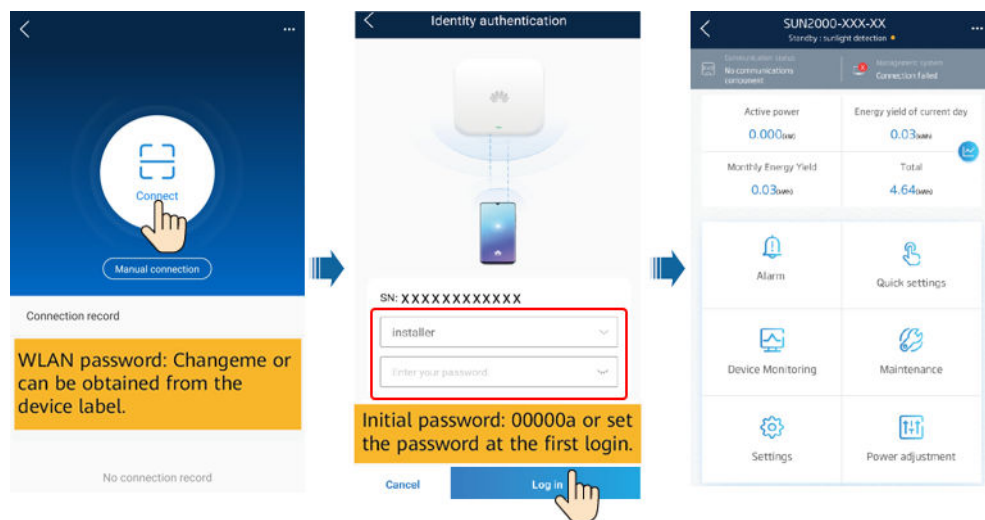

NOTE

- Code scanning: Tap **Connect** to access the scanning screen, place the QR code or bar code of the solar inverter in the scan frame. The device will be automatically connected after the code is identified.
- During the login, if five consecutive invalid password entries are made (the interval between two consecutive entries is less than 2 minutes), the account will be locked for 10 minutes. The password should consist of six characters.
- To ensure account security, change the password periodically and keep the new password in mind. A password left unchanged for a long period of time may be stolen or cracked. If a password is lost, devices cannot be accessed. In these cases, the user is liable for any loss caused to the PV plant.

Step 3 Tap **Settings > Communication configuration** and set the parameters for **Router connection settings**.

Figure 6-3 Inverter communication settings

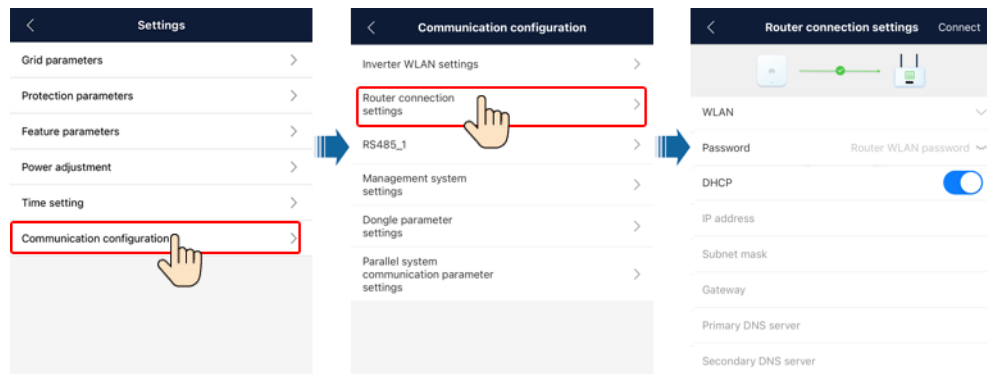

Table 6-1 Parameter description

Type	Parameter	Setting Description
Inverter's connection to a router	WLAN list	Specifies the name of the wireless network.
	Password	Specifies the password for logging in to the wireless network.
	DHCP	<ul style="list-style-type: none"> Enable this parameter if you use the IP address automatically allocated by the router. In this case, the values of IP address, Subnet mask, Gateway, Primary DNS server, and Secondary DNS server are automatically allocated. Disable this parameter if you do not use the IP address automatically allocated by the router. In this case, you need to set the values of IP address, Subnet mask, Gateway, Primary DNS server, and Secondary DNS server.
	IP address	Specifies the IP address for the router to which the inverter WLAN network connects. The IP address must be in the same network segment as the router IP address.
	Subnet mask	Specifies the router subnet mask.
	Gateway	Specifies the router gateway address.
	Primary DNS server	Specifies the address for the primary domain name service (DNS) server.
	Secondary DNS server	Specifies the address for the secondary DNS server.

Table 6-2 Description of icons

Icon	Router	Management system

Meaning	Disconnected	Incorrect password	Connected; signal strength	Connection failed.	Connection is successful.
----------------	--------------	--------------------	----------------------------	--------------------	---------------------------

----End

6.1.2 4G Communication Networking

Procedure

Step 1 Run the FusionSolar app and go to the **Device commissioning** screen. (Perform this step only for the FusionSolar app.)

Figure 6-4 Device commissioning

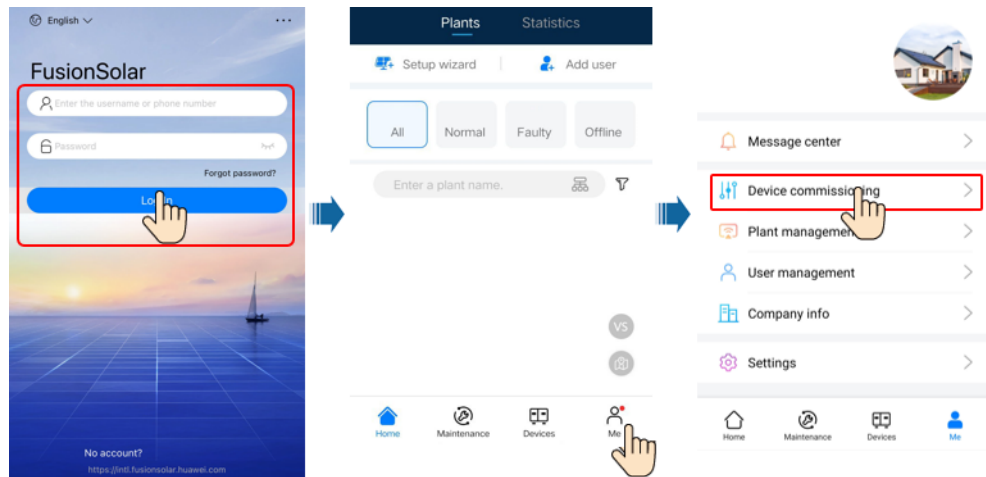

Step 2 Connect to the inverter.

Figure 6-5 Connecting to the inverter

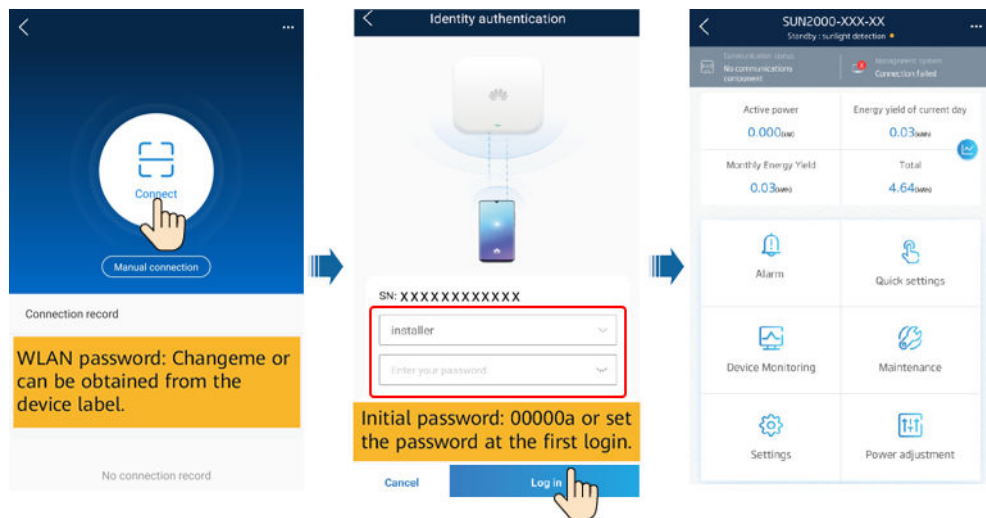

 NOTE

- Code scanning: Tap **Connect** to access the scanning screen, place the QR code or bar code of the solar inverter in the scan frame. The device will be automatically connected after the code is identified.
- During the login, if five consecutive invalid password entries are made (the interval between two consecutive entries is less than 2 minutes), the account will be locked for 10 minutes. The password should consist of six characters.
- To ensure account security, change the password periodically and keep the new password in mind. A password left unchanged for a long period of time may be stolen or cracked. If a password is lost, devices cannot be accessed. In these cases, the user is liable for any loss caused to the PV plant.

Step 3 Tap **Settings > Communication configuration** and set **Mobile network** parameters.

Figure 6-6 Inverter communication settings

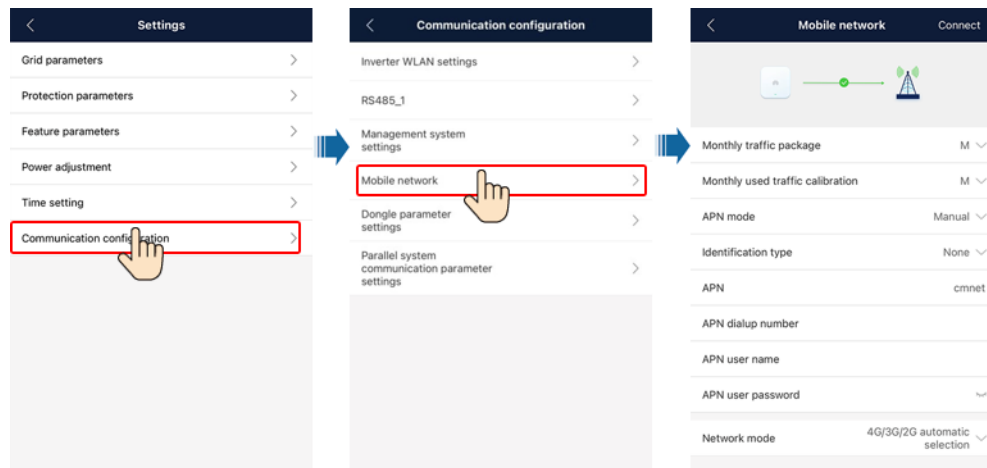
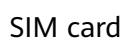
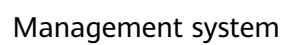









Table 6-3 Parameter description

Type	Parameter	Setting Description
4G	APN mode	<ul style="list-style-type: none"> • Set the parameters related to the SIM card based on the information provided by the SIM card carrier. • When APN mode is set to Manual, APN, APN dialup number, APN user name, and APN user password are all displayed and configurable. When APN mode is set to Automatic, these parameters are not displayed.
	APN	
	APN dialup number	
	APN user name	
	APN user password	
	Network mode	
	PIN	

Table 6-4 Description of icons

Icon	SIM card	Management system
		

					
Meaning	Enter the PIN.	No SIM card	Not connected; signal strength	Connection failed.	Connection is successful.
Icon				N/A	N/A
Meaning	Enter the PUK.	Failed to read the card. The signal is poor or the subscriber is in arrears.	Connected; signal strength	N/A	N/A

----End

6.1.3 FE Communication Networking

Step 1 Run the FusionSolar app and go to the **Device commissioning** screen. (Perform this step only for the FusionSolar app.)

Figure 6-7 Device commissioning

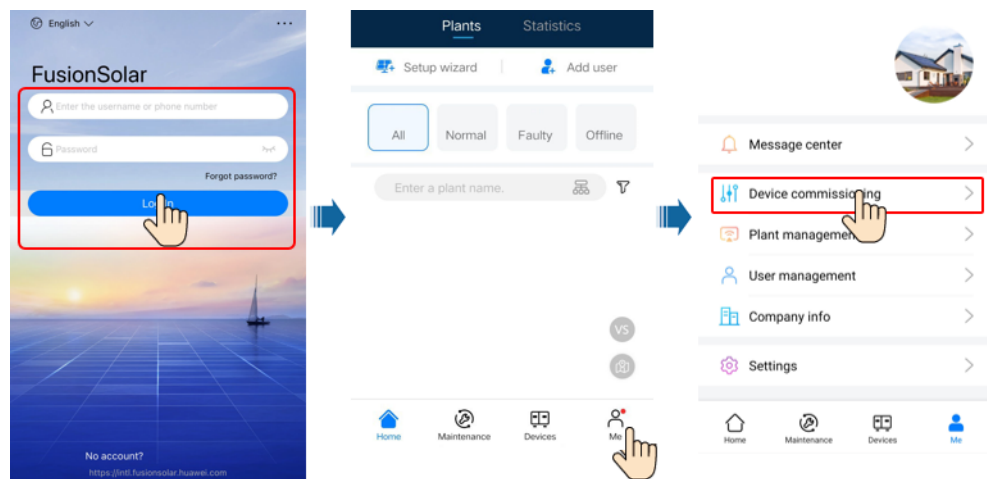

Step 2 Connect to the inverter.

Figure 6-8 Connecting to the inverter

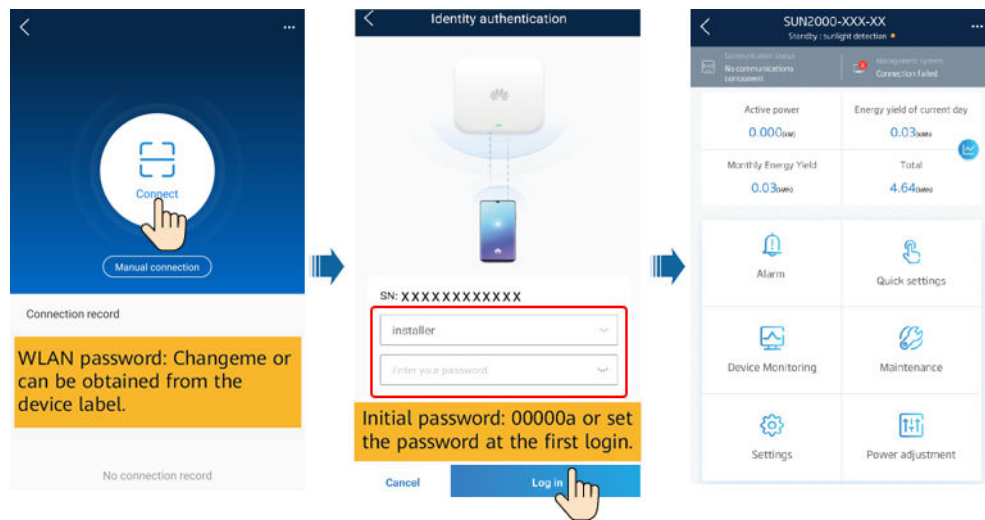

NOTE

- Code scanning: Tap **Connect** to access the scanning screen, place the QR code or bar code of the solar inverter in the scan frame. The device will be automatically connected after the code is identified.
- During the login, if five consecutive invalid password entries are made (the interval between two consecutive entries is less than 2 minutes), the account will be locked for 10 minutes. The password should consist of six characters.
- To ensure account security, change the password periodically and keep the new password in mind. A password left unchanged for a long period of time may be stolen or cracked. If a password is lost, devices cannot be accessed. In these cases, the user is liable for any loss caused to the PV plant.

Step 3 Tap **Settings > Communication configuration** and set the parameters for **Router connection settings**.

Figure 6-9 Inverter communication settings

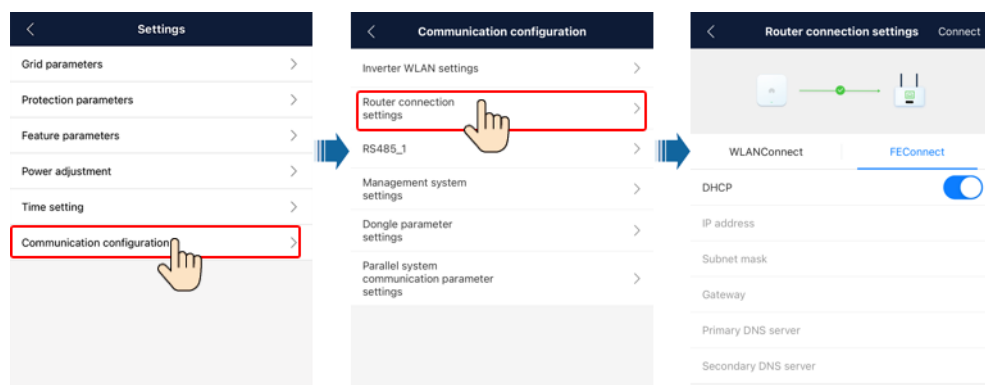







Table 6-5 Parameter description

Type	Parameter	Setting Description
Inverter's connection to a router	DHCP	<ul style="list-style-type: none"> Enable this parameter if you use the IP address automatically allocated by the router. In this case, the values of IP address, Subnet mask, Gateway, Primary DNS server, and Secondary DNS server are automatically allocated. Disable this parameter if you do not use the IP address automatically allocated by the router. In this case, you need to set the values of IP address, Subnet mask, Gateway, Primary DNS server, and Secondary DNS server.
	IP address	Specifies the IP address for the router to which the inverter WLAN network connects. The IP address must be in the same network segment as the router IP address.
	Subnet mask	Specifies the router subnet mask.
	Gateway	Specifies the router gateway address.
	Primary DNS server	Specifies the address for the primary domain name service (DNS) server.
	Secondary DNS server	Specifies the address for the secondary DNS server.

Table 6-6 Description of icons

Icon	Router			Management system	
					
Meaning	Connection failed.	Connecting ...	Connection is successful.	Connection failed.	Connection is successful.

----End

6.2 Exporting Inverter and Smart Dongle Logs

Procedure

- Step 1** Log in to the management system, click **Plants**, and choose **Log Export** under **Device**.

Figure 6-10 System Settings page

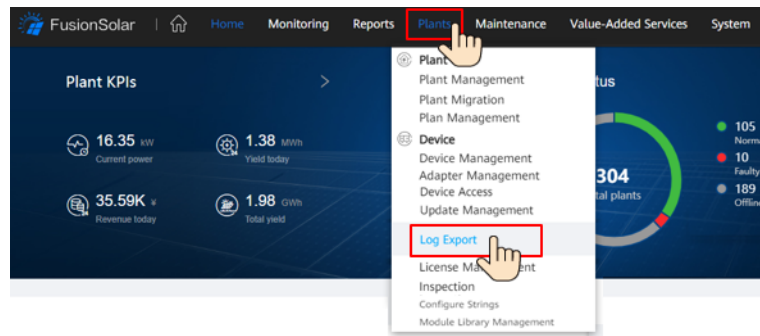

Step 2 Select devices and click **Start Export** to create an export task. When the export status is **Succeeded**, select the corresponding logs and click **Save Log** to save the logs locally.

Figure 6-11 Exporting and saving logs

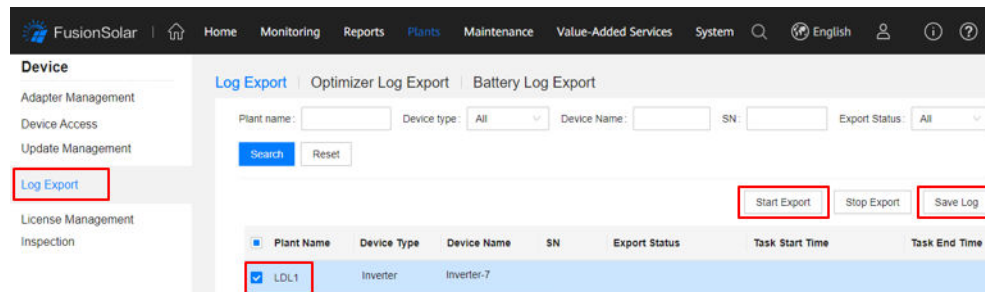

----End

6.3 Upgrading the Inverter and Smart Dongle Software

Prerequisites

- You have contacted Huawei technical support engineers to upload the upgrade package of the software.
- The FusionSolar app is recommended when the inverter is connected to the FusionSolar Smart PV Management System. The SUN2000 app is recommended when the inverter is connected to other management systems.
- You have downloaded and installed the FusionSolar app which can be obtained by searching for **FusionSolar** in Huawei AppGallery or scanning the QR code.



FusionSolar App

- SUN2000 APP: Search for "SUN2000" in Huawei AppGallery, download the latest installation package, and install the SUN2000 app by following the instructions.

Connecting to the Inverter over the App

Step 1 Ensure that the Smart Dongle to be upgraded is inserted into a running inverter. Wait for more than 2 minutes, remove the Smart Dongle, and connect the WLAN module, Bluetooth module, or USB data cable to the inverter.

NOTE

Perform this step if communication with the inverter over a WLAN module, Bluetooth module, or USB data cable is required.

Step 2 Run the FusionSolar app and go to the **Device commissioning** screen. (Perform this step only for the FusionSolar app.)

Figure 6-12 Device commissioning

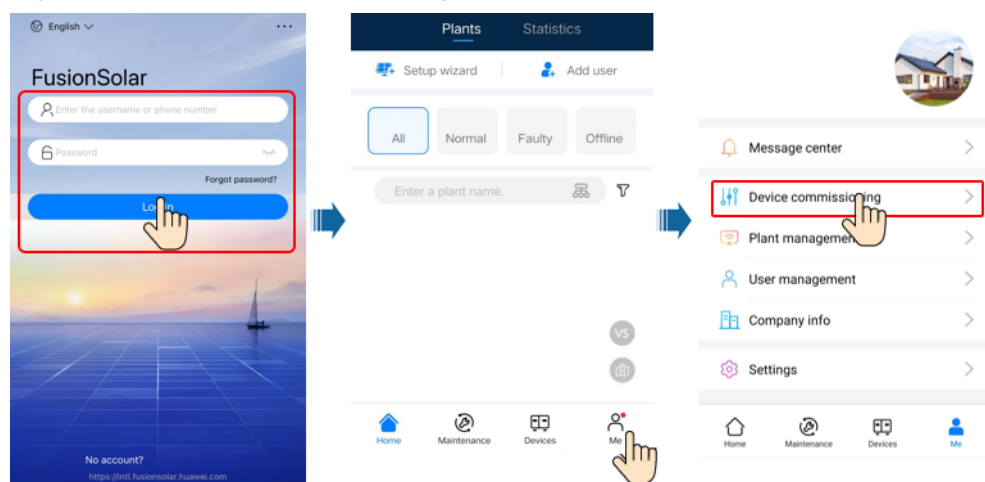

Step 3 Connect to the inverter.

Figure 6-13 Connecting to the inverter

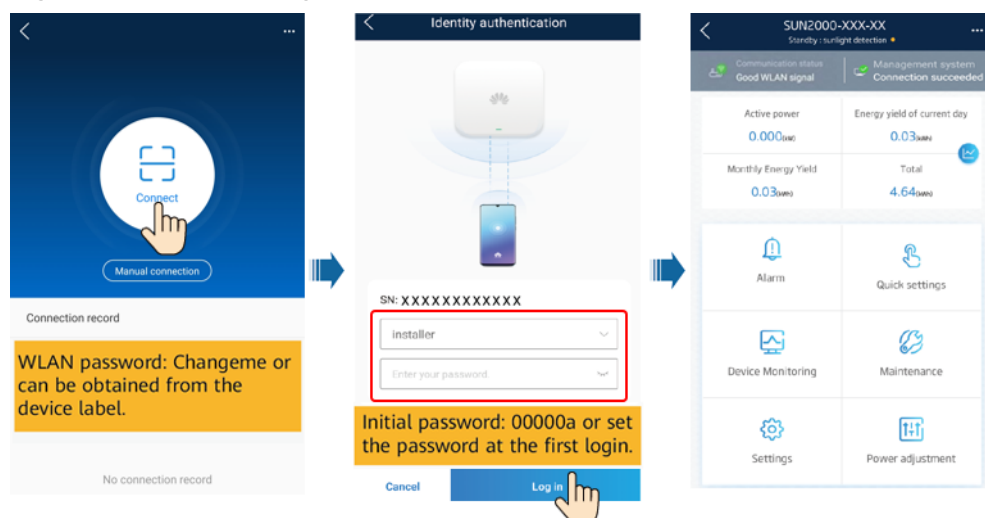

 NOTE

- Code scanning: Tap **Connect** to access the scanning screen, place the QR code or bar code of the solar inverter in the scan frame. The device will be automatically connected after the code is identified.
- During the login, if five consecutive invalid password entries are made (the interval between two consecutive entries is less than 2 minutes), the account will be locked for 10 minutes. The password should consist of six characters.
- To ensure account security, change the password periodically and keep the new password in mind. A password left unchanged for a long period of time may be stolen or cracked. If a password is lost, devices cannot be accessed. In these cases, the user is liable for any loss caused to the PV plant.

Step 4 Upgrade a device as prompted.

 NOTE

- Prepare the upgrade package before upgrading the device.
- Delivering an upgrade command to an inverter may cause power grid connection failure of the inverter and affect the energy yield.

Figure 6-14 Upgrading a device

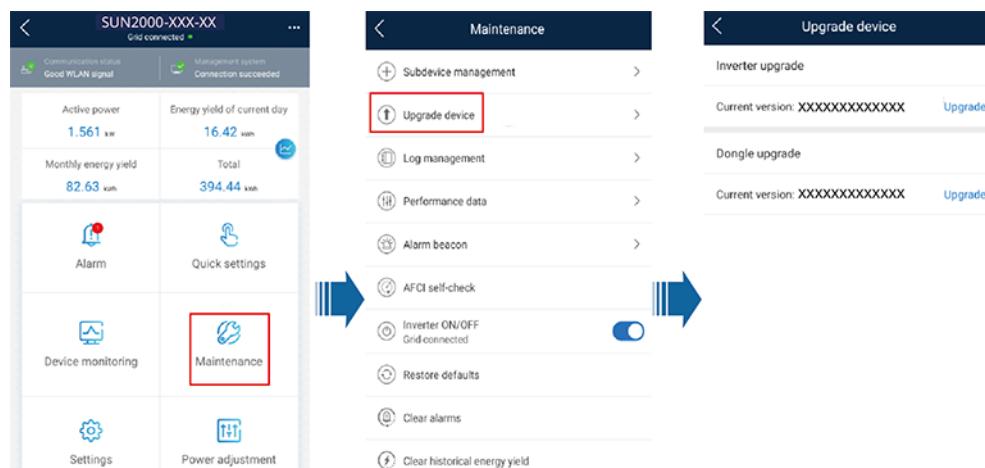

----End

Connecting to the Smart Dongle over the App

 NOTE

- Only SDongleA-05 or SDongleB-06 supports this upgrade mode.
- The screenshots are for reference only. The actual screens may vary.

Step 1 Run the FusionSolar app and go to the **Device commissioning** screen. (Perform this step only for the FusionSolar app.)

Figure 6-15 Device commissioning

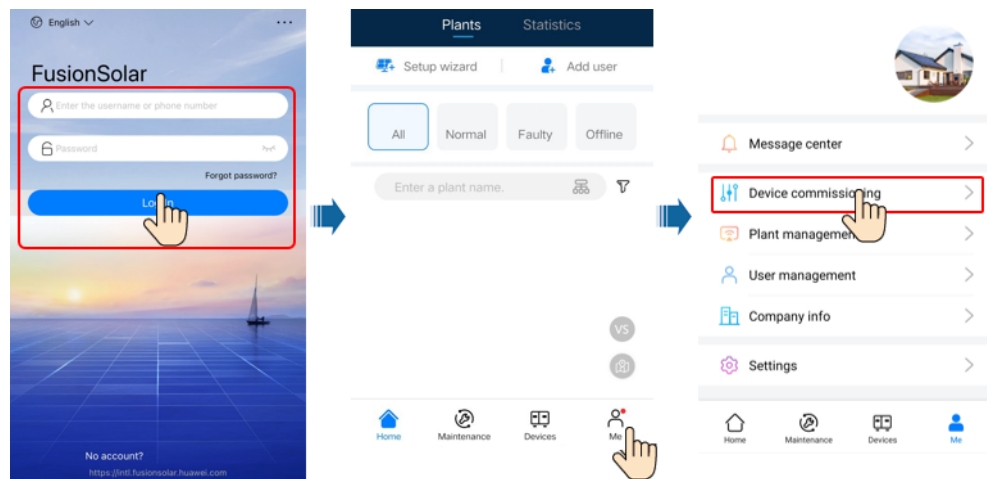

Step 2 Connect the Smart Dongle.

Figure 6-16 Connecting the Smart Dongle

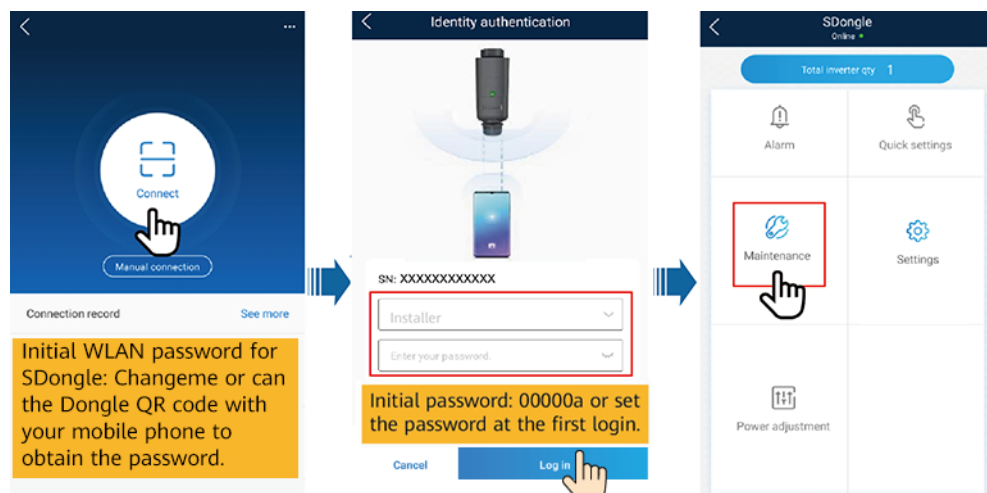

Step 3 Upgrade a device as prompted.

NOTE

Prepare the upgrade package before upgrading the device.

Figure 6-17 Upgrading a device

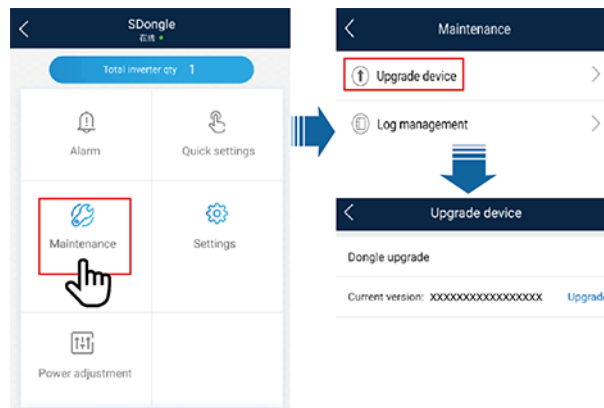

----End

Over the WebUI

- Step 1** Log in to the management system, click **Settings** in the upper-right corner to go to the **System Settings** page, and choose **Upgrade Management**. On the **Device Upgrade** tab page, click **Create Update Task**, and create an upgrade task.

Figure 6-18 Creating an upgrade task

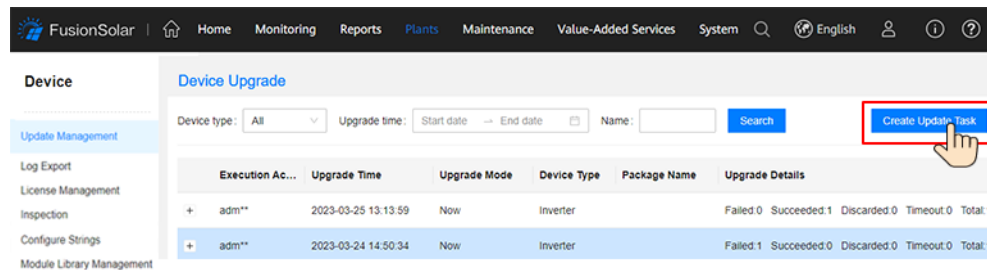

- Step 2** Set **Upgrade**, **Device type**, **Target version**, and **Device selection**, and click **OK** to upgrade the devices.

NOTE

If the update after confirmation mode is selected, the device can be updated only after the user's consent is obtained.

Figure 6-19 Device upgrade

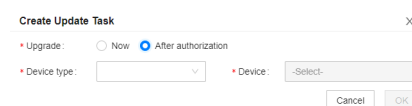

----End

6.4 Updating the Device List

When a device connected to the Device List is deleted or replaced, you need to update the plant device information on the **Device Management** page.

Prerequisites

The PV plant to be updated communicates properly with the FusionSolar Smart PV Management System.

Procedure

- Step 1** On the home page of the management system, select the plant to be modified from the plant list.
- Step 2** On the **Device Management** page, select the target device, and then delete or replace the device.

Figure 6-20 Device management

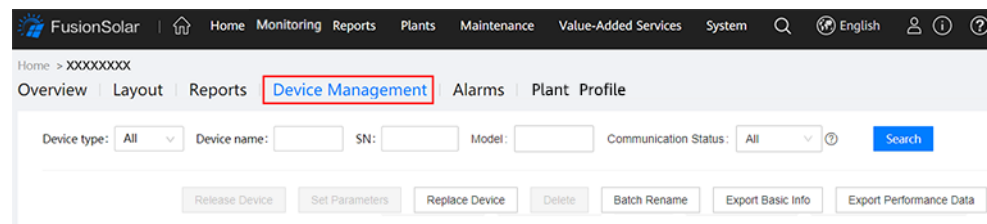

NOTE

Replacing inverters does not affect the total energy yield of the PV plant.

----End

6.5 Replacing the Smart Dongle and the Master Inverter

6.5.1 Replacing the Smart Dongle

Replacing a Faulty Smart Dongle with a Smart Dongle of the Same Model

NOTE

If SDongleA-01, SDongleB-06, SDongleA-03, or SDongleA-05 is faulty, it must be replaced with a Smart Dongle of the same model.

- Step 1** Remove the faulty Smart Dongle.
- Step 2** Replace the SIM card. (Perform this step when the 4G communication mode is used.)
 - If the purchased Smart Dongle has a built-in SIM card, replace the Smart Dongle without replacing the SIM card.
 - If the purchased Smart Dongle does not have a built-in SIM card, use the SIM card in the faulty Smart Dongle.
- Step 3** Install a new Smart Dongle onto the inverter where the faulty Smart Dongle was installed.

- Step 4** Set the password for logging in to the WLAN. (Perform this step when the WLAN communication mode is used.)
- Step 5** Log in to the FusionSolar app and tap the plant name on the **Home** screen to access the plant screen. Tap **Devices**, select the faulty Smart Dongle, tap **Device Replacement**, and replace the Smart Dongle as prompted.

Figure 6-21 Device Replacement

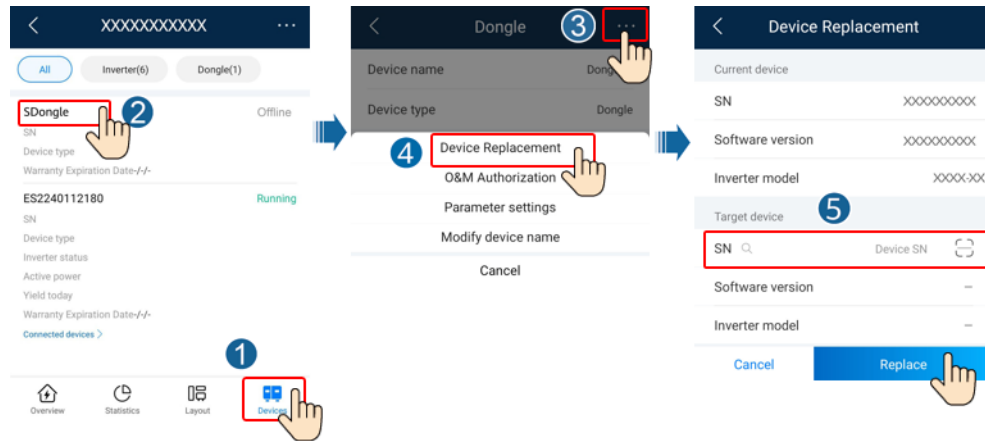

----End

Replacing a Faulty Smart Mobile-4G with an SDongleA-03

NOTE

- Replacing a Faulty Smart Mobile-4G-CN with an SDongleA-03-CN.
- Replacing a Faulty Smart Mobile-4G-EU with an SDongleA-03-EU.

- Step 1** Check that the software version of the master inverter supports the SDongleA-03. If the software version is not compatible, update the software version or replace the inverter.
- Step 2** Remove the faulty Smart Dongle.
- Step 3** Replace the SIM card. (Perform this step when the 4G communication mode is used.)
- If the purchased Smart Dongle has a built-in SIM card, replace the Smart Dongle without replacing the SIM card.
 - If the purchased Smart Dongle does not have a built-in SIM card, use the SIM card in the faulty Smart Dongle.
- Step 4** Log in to the FusionSolar app and tap the plant name on the **Home** screen to access the plant screen. Tap **Devices** and add a new Smart Dongle.

Figure 6-22 Add device

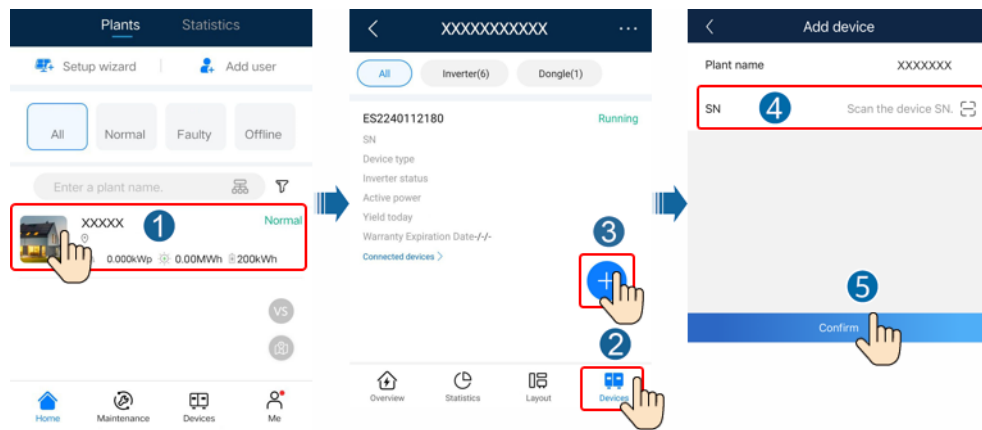

----End

6.5.2 Replacing the Master Inverter

Step 1 When the MBUS is used for networking, use the app to change the cascading mode of the original master inverter to RS485 through **Quick settings**.

NOTE

Tap **Search for cascaded inverters** and exit after 5s.

Figure 6-23 Setting inverter cascading

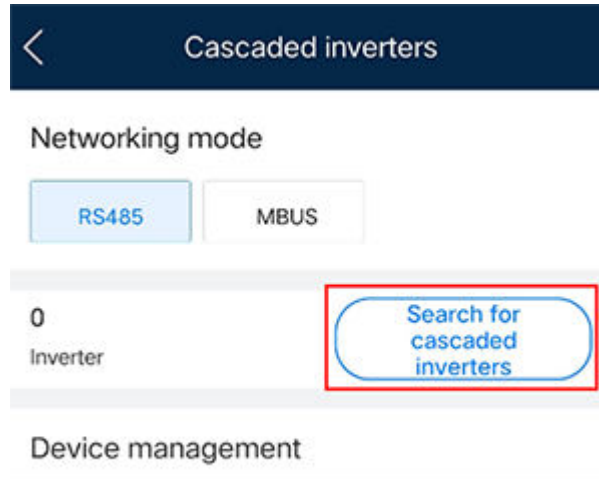

Step 2 Remove the Smart Dongle and install it on the new master inverter.

Step 3 Set up a site and commission the new master inverter.

----End

6.6 Troubleshooting Common Issues

Table 6-7 Common faults and troubleshooting measures

Fault	Cause	Troubleshooting
Huawei FusionSolar Smart PV Management System shows that the communication with the inverter is interrupted.	<ol style="list-style-type: none"> 1. The RS485 cables among inverters are loose or disconnected. 2. The PV string is not properly connected, and the inverter has no DC input. 3. The baud rate or RS485 address of the inverter is changed. 4. The Smart Dongle is faulty. 	<ol style="list-style-type: none"> 1. Check that the RS485 cables among inverters are properly connected and tightened. 2. Check that the inverter is correctly connected and power on the inverter. 3. Check that the baud rate and RS485 address of the inverter are set correctly. 4. Replace the Smart Dongle.
The SN of the Smart Dongle cannot be identified by the FusionSolar app.	The bar code is damaged and cannot be scanned.	Manually enter the SN on the Add Device screen on the FusionSolar app.
The devices connected to the Smart Dongle are not connected to the Huawei FusionSolar Smart PV Management System properly.	<ol style="list-style-type: none"> 1. Check whether the inverter software version meets the requirements. If not, upgrade the inverter to a specified version or later. 2. Check that the RS485 communications cables are connected properly. 3. Check that the RS485 communications parameters of the inverter are set correctly. 4. Check that the inverter communications parameters are correctly set. 	If the inverters cannot be detected after troubleshooting, the Smart Dongle is faulty. Contact Huawei technical support.
After the Smart Dongle is replaced, the connection to the management system using the original SIM card fails.	The SIM card is bound to the original Smart Dongle.	Contact the carrier of the SIM card to unbind the SIM card from the Smart Dongle.

7 Acronyms and Abbreviations

A	
app	Application
L	
LCD	liquid crystal display
S	
SN	Serial Number
U	
USB	Universal Serial Bus